

 **contardi**

indoor



BLENDING
TECHNOLOGY
& CREATIVE
DESIGN

“Mentre mio padre stava dando forma alla luce, stavo imparando come modellare un’azienda”

Achille Carcano, Titolare



Paola & Achille Carcano

1. La nostra storia, la nostra famiglia *Our history, our family*

Contardi, una giovane azienda con una lunga storia. Il primo prodotto a marchio Contardi è stato lanciato nel 2006. Successivamente, l'azienda ha iniziato una crescita costante anno dopo anno, che si è consolidata negli ultimi anni a livello internazionale. Contardi è ora una solida realtà con sede produttiva ed amministrativa in Brianza, il cuore pulsante della manifattura Made in Italy. Tutto comincia grazie al genio creativo di Michele Carcano, che aveva una grande passione per la prototipazione. La sua esperienza nell'azienda Stilnovo gli consentì di sviluppare una notevole competenza nell'illuminazione. Da quel momento, gli eredi di Michele, Achille e Paola Carcano, hanno preso le redini dell'azienda, e sono ora supportati da un team unito e compatto. Come in una famiglia allargata, alcuni dei suoi membri sono parte di Contardi sin dagli albori. Contardi è oggi sinonimo di servizio, qualità, e flessibilità. Queste caratteristiche hanno consentito all'azienda di guadagnarsi la fiducia di architetti, interior designer e consulenti di illuminazione, figure professionali sempre alla ricerca di originalità e design decorativo e funzionale, oltre che di esperienza e servizio di alto livello.

We are a young company with a long history. Our first Contardi branded product dates back to 2006, thereafter the company began to constantly grow year after year, and the expansion has consolidated in the last six years. Contardi is now a well-established company headquartered in the Brianza district - the beating heart of the “Made in Italy” manufacturing. Before then, Contardi had a 30-year history of successful collaborations, providing its lighting expertise to some of the most iconic companies on the Italian design scene. It all started from the creative genius of Michele Carcano, who had a real passion for prototypes and worked for Stilnovo – one of the first companies to build a reputation as a lighting designer. Fast-forward to today, and Michele Carcano’s heirs – Achille and Paola Carcano – have taken the reins of the company, supported by a very close-knit team, more similar to an extended family working together, with some of its members having been part of it since its inception. Contardi is now synonymous with service, quality and flexibility, having become a reliable reference point for architects, interior decorators and lighting consultants who are in search of original and well-designed decorative and functional lighting as well as an unparalleled expertise and service.

1a. Contardi USA

Il percorso aziendale di Contardi ha portato l'azienda ad affacciarsi sul mercato statunitense già nel 2015. Questo mercato ha oggi una grande importanza per il brand. Con l'apertura e presenza della filiale americana, Contardi risponde in tempo reale alle esigenze provenienti da questo mercato.

L'apertura della filiale americana ci garantisce un presidio diretto in uno dei punti nevralgici del mondo.

Forte presenza nell'e-commerce.

L'azienda è certificata ETL.

Contardi's business path led the company to enter the US market as early as 2015. Today this market is of great importance for the brand. With the opening and presence of the American branch, Contardi responds in real time to the needs of this market.

The American branch, which is ETL certified, guarantees our brand a direct participation in one of the key regions of the world, with a strong presence in e-commerce.

“While dad was giving a shape to light, I was learning how to shape a company”

Achille Carcano, Owner

2. Contardi Contract Division

Lavoriamo fianco a fianco con architetti, interior designer, e consulenti di illuminazione. Grazie a questo Contardi ha sviluppato la capacità sia di tradurre i concetti dei designer, che di soddisfare le richieste del cliente e di rispettare il budget dei progetti. **Hotels, ristoranti, e yacht** diventano il palcoscenico della versatilità dei nostri prodotti, che si uniscono perfettamente all'ambiente circostante, indipendentemente dallo stile e dalle caratteristiche del progetto stesso. La Divisione Contract Contardi offre un servizio mirato in base alle richieste del cliente:

*We work closely with architects, interior decorators and lighting designers, so we are able to catch and translate the designer's concepts, meeting the client's needs and the budget of the project. **Hotels, restaurants and yachts** become stages where the versatility of products blends perfectly with the surroundings, independently from the style and the characteristics of the project itself. Contardi Contract Division offer a dedicated service on customer requests:*

**BESPOKE
MODIFIED STOCK
VALUE ENGINEERED**



The Hoxton, Rome



Shangri La, Hong Kong



Mayfair Townhouse, London



The Address Downtown, Dubai



Lutetia Hotel, Paris



The Carlyle, New York

3. Sartorialità e tecnologia Tailoring and avant-grade technology

Per Contardi è stato più volte usato l'aggettivo di **"Couturier della Luce"**. Nel corso degli anni, siamo riusciti a guadagnarci questa reputazione per il nostro approccio sartoriale, per la varietà dei materiali usati, per l'eleganza delle finiture, e per la loro combinazione con le più innovative tecnologie LED. La nostra collezione è disegnata per assicurare che la qualità dell'illuminazione risponda alle esigenze contemporanee.

Internationally renowned as the "Couturier of Contemporary Lighting", we have earned this reputation over the years for our skilful sartorial approach, for the variety of materials used, as well as the elegance of the finishes combined with the most innovative LED technology, all designed to ensure that the quality of the lighting responds to contemporary requirements.

4. Flessibilità Flexibility

La flessibilità è la nostra forza. Ci contraddistingue. L'ampia varietà di stile rappresenta la capacità di interpretare le diverse personalità dei nostri clienti e di adattarsi a molteplici contesti.

Flexibility is our strength and what distinguishes us from the rest. Style variety does not mean a lack of identity though. On the contrary, it means a capacity to interpret different styles and to adapt to different settings.

5. Sostenibilità Sustainability

Il nostro impegno per un business sempre più sostenibile è costante. Siamo ora pronti per la nuova sfida di ridurre ulteriormente il nostro impatto ambientale con una serie di obiettivi che miriamo a raggiungere e che rappresentano il nostro orientamento in termini di sostenibilità.

Our commitment to an increasingly sustainable business has emerged over the course of the last few years and, after obtaining some great achievements, we are now ready for a new challenge to further reduce our environmental impact with a clear set of targets, which constitute our Pole Star in terms of sustainability.

6. Certificazioni Certification

La presenza di un Brand sul mercato internazionale non può oggi prescindere dalle certificazioni. Contardi risponde a questa esigenza investendo risorse e competenza.

Oggi l'azienda è certificata ETL per il mercato americano e CCC per il mercato cinese.

Grazie all'ufficio tecnico interno, Contardi riesce a soddisfare le richieste di certificazioni quali: SABER per l'Arabia Saudita, CoC per il Marocco, EAC per il mercato russo.



Today, a brand's presence on the international market requires the ability to provide certifications. Contardi responds to this need by investing resources and expertise. Our company is ETL certified for the American market, and CCC for the Chinese market. Thanks to the internal technical office, Contardi is able to satisfy requests for certifications such as SABER for Saudi Arabia, CoC for Morocco, and EAC for the Russian market.

A

- 12 **AIR**
- 18 **ARCIPELAGO** so, ta
- 26 **ASIA** so, ap, ta, pl
- 34 **AUDREY** so, ta, fl

B

- 42 **BACH**
- 46 **BEAM**
- 52 **BELLE**
- 56 **BOGOTÀ**

C

- 62 **CALYPSO** so, fl
- 80 **CLESSIDRA**
- 84 **CORNELIA & MESSALINA**
- 92 **CUBE**

D

- 96 **DISCUS** so, ap
- 106 **DORIAN** so, fl

E

- 114 **ECLISSE 2.0**
- 118 **EMMA** ap, ta, pl

F

- 126 **FLEXILED** ap, fl
- 132 **FLY** so, ap, picture

G

- 144 **G+T** so, ap, reading, battery

K

- 158 **KUBRIC**

M

- 162 **MANHATTAN**
- 166 **MELANOCETUS**
- 172 **MIKADO** so, ap, ta, fl
- 184 **MUSE LANTERN**

O

- 188 **ONGO** battery

S

- 192 **SOLITARIO** so, ap, pl
- 202 **STARDUST**
- 206 **STICK** so, ap

T

- 218 **TENEBRA** wired, battery
- 224 **TREASURE**

U

- 228 **UP** ap, ta, fl

V

- 234 **VEGAS**

CONTARDI SARTORIA

Contardi Tailoring

A

- 2i **ATHENA**

C

- 6i **CIRCUS** so, pl
- 12i **COCO MEGA & DELUXE** ap, ta
- 16i **COCO & COCONETTE**

O

- 22i **OVALE** ta, fl

T

- 26i **TONDA** ap, ta, fl

Lampada a sospensione
Suspension lamp



Air
12

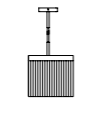

Arcipelago
18



Asia
26

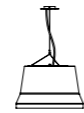

Audrey
34



Belle
52

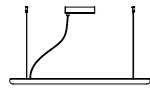

Bogotá
56



Calypso
62

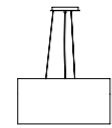

Circus & Circus LED
6i



Cornelia & Messalina
84



Discus
96



Dorian
106

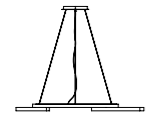

Eclisse 2.0
114

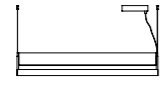

Fly
132



G+T
144



Kubric
158

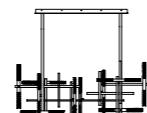

Mikado
172



Solitario
192

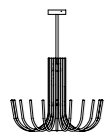

Stardust
202

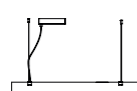

Stick
206



Tenebra
218



Vegas
234

Lampada a parete
Wall lamp

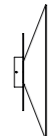

Asia
26



Bach
42



Coco Mega & Deluxe
12i



Coco & Coconette
16i



Discus
96



Emma
118



Flexiled
126



Fly
132



Fly picture
126

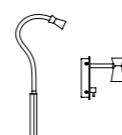

G+T
144



Manhattan
162

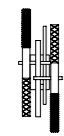

Mikado
172



Solitario
192



Stick
206



Tonda
26i



Up
228

Lampada da lettura
Reading lamp



Flexiled
126

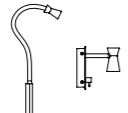

G+T
144



Manhattan
162



Tonda
26i



Up
228

Lampada a soffitto
Ceiling lamp

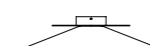

Asia
26

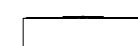

Circus & Circus LED
6i

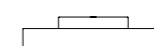

Discus
96



Emma
118



Melanocetus
166



Solitario
192

Lampada da terra
Floor lamp



Audrey
34



Calypso
62



Cube
92



Dorian
106



Flexiled
126



Mikado
172



Muse Lantern
184



Ovale
22i



Tonda
26i



Up
228

Lampada da tavolo
Table lamp



Arcipelago
18



Asia
26



Athena
2i

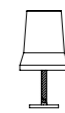

Audrey
34



Beam
46

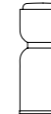

Clessidra
80



Coco Mega & Deluxe
12i

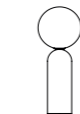

Emma
118



Mikado
172



Ongo battery
188



Ovale
22i



Treasure
224

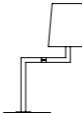

Tonda
26i



Up
228

Lampada da batteria
Battery lamp



G+T battery
144



Ongo Battery
188



Tenebra
218

Air
Adam Tihany



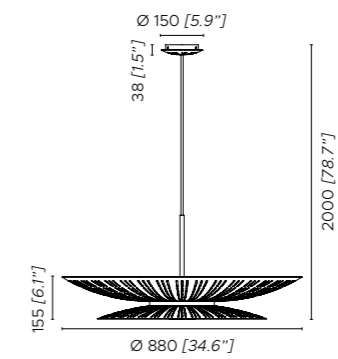



WHAT'S AIR?

The new eco-friendly AIR suspension light, conceived by the renowned **Adam Tihany**

Materiale **ecologico** "NPU GREEN"
100% riciclabile
100% sustainable
Senza adesivi, coloranti e prodotti chimici
Atossica grazie alla finitura a base di acqua.

Air: per un impatto più sostenibile nel mondo del design

Eco-friendly material "NPU GREEN"
100% recyclable
100% sustainable
free of adhesives, dyes and chemicals
 The finishing is water-based and therefore **non-toxic**.

Air: for a great impact on the world of design



1. Materiale ecologico "NPU GREEN", laccato bianco perla
2. Diffusore vetro bianco opale

Altri colori disponibili su richiesta

Fonte luminosa - Light source
 220-240V: 1 X 15W Custom LED
 110V: 1 X 15W Custom LED

Dimmerabile / dimmable

1. Eco-friendly material "NPU GREEN", pearl white finish
2. Opal white glass diffuser

Other colours available on demand

Arcipelago

Servomuto



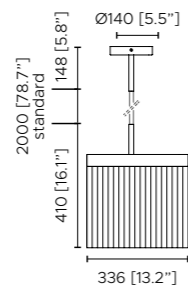



1. Struttura ottone satinato

- 2. Frange verde salvia
- 3. Frange blu nebbia
- 4. Frange cognac
- 5. Frange sabbia
- 6. Frange aragosta
- 7. Frange ruggine

Fonte luminosa - Light source
 220-240V: 1 x 18W Custom LED
 110V: 1 x 18W Custom LED

Ta - dimmerabile a tre intensità / So - dimmerabile, compatibile con sistemi di controllo remoto
 Ta - dimmable with three intensity levels / So - dimmable compatible with remote control system

1. Satin brass frame

- 2. "Sage green colour" fringes
- 3. "Fog blue colour" fringes
- 4. "Cognac colour" fringes
- 5. "Sand colour" fringes
- 6. "Aragosta colour" fringes
- 7. "Rust colour" fringes

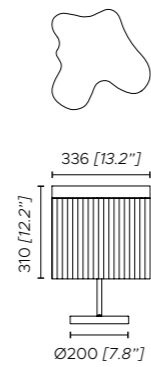

Asia

Federico Perri



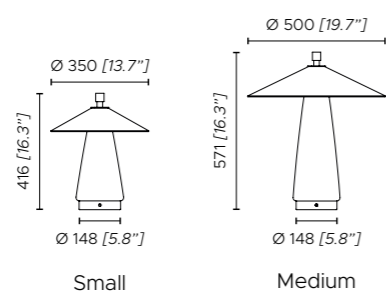

1. Struttura "nickel dorato" satinato
2. Struttura "bronzo-nickel" spazzolato
3. Vetro trasparente
4. Paralume cotone bianco
5. Paralume colore antracite (esterno)
6. Diffusore in vetro bianco opale

1. Satin "gold nickel" finish
2. Brushed "bronze-nickel" finish
3. Transparent glass
4. Cotton white shade
5. Cotton anthracite shade
6. White opal glass diffuser

Fonte luminosa - Light source

220-240V: Ta small 1 x 13W Strip LED / Ta medium 1 x 20W Strip LED / So-Ap-PI 1 x 60W max COB LED
 110V: So-Ap-PI 1 x 60W max COB LED

So, ap, pl - dimmerabile su richiesta, compatibile con sistemi di controllo remoto / Ta - dimmerabile, push sulla base
 So, ap, pl - dimmable on request, compatible with remote control system / Ta - dimmable, push on the base

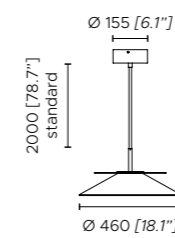
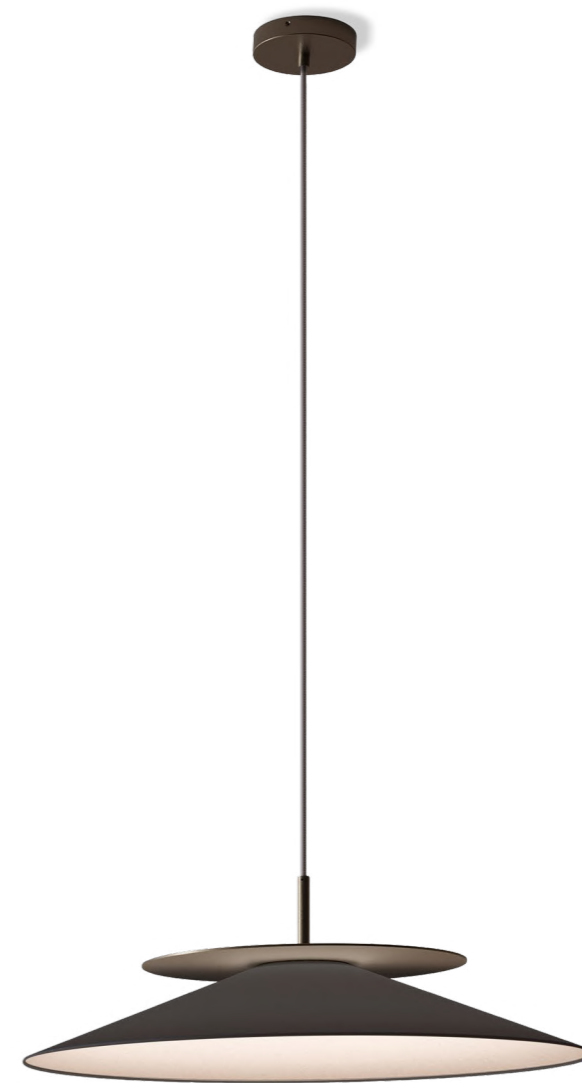

Medium

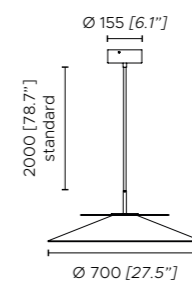

Large

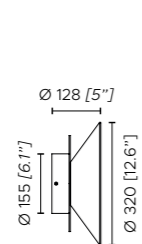

Ap/pi small

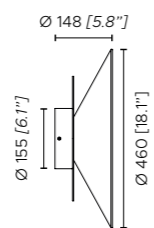

Ap/pi medium

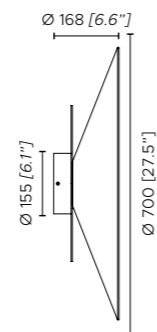

Ap/pi large



Audrey
Massimiliano Raggi



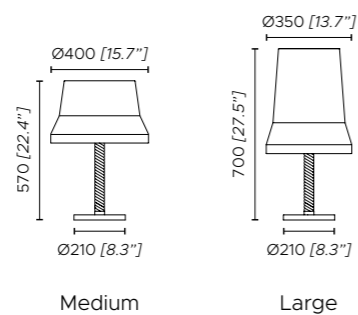

- 1. Base laccato nero lucido
- 2. Stelo in corda di seta intrecciata nera
- 3. Paralume cotone bianco
- 4. Bouclè color sabbia
- 5. Passamaneria in velluto senape
- 6. Passamaneria in velluto arancione
- 7. Passamaneria in velluto blu avio
- 8. Passamaneria in velluto nera

- 1. Glossy black lacquered base
- 2. Stem in black braided silk rope
- 3. White cotton shade
- 4. "Sand colour" Bouclè
- 5. Mustard colour velvet trim
- 6. Orange colour velvet trim
- 7. Aviation blue colour velvet trim
- 8. Black colour velvet trim

Fonte luminosa - Light source
 220-240V: Ta 1 X E27 LED / FI-So 3 x E27 LED
 110V: Ta 1 x E26 LED / FI-So 3 x E26 LED

Ta - dimmerabile su richiesta, disponibile versione con dimmer per LED su cavo, compatibile solo con lampadine LED
 So - dimmerabile, compatibile con sistemi di controllo remoto
 Ta - dimmable, available, on demand, dimmer switch on the cable (to use dimmable LED light bulbs only)
 So - dimmable, compatible with remote control system

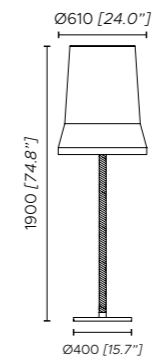

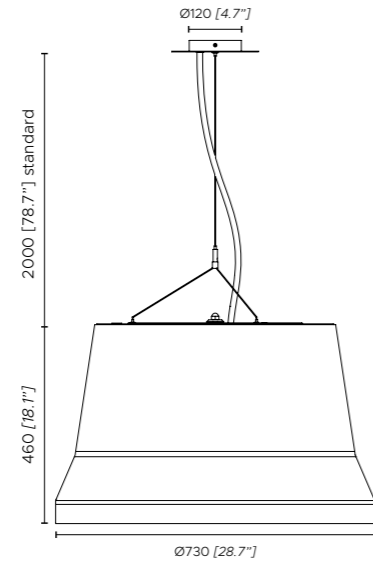

Bach

Massimiliano Raggi



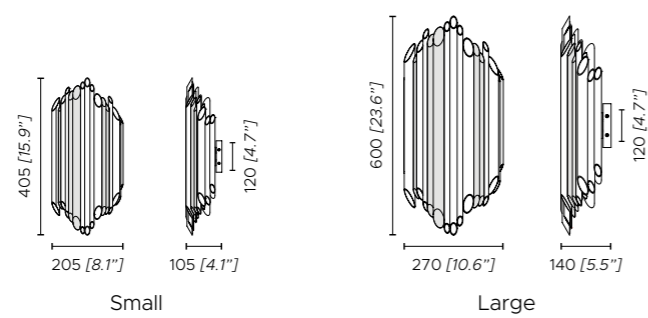
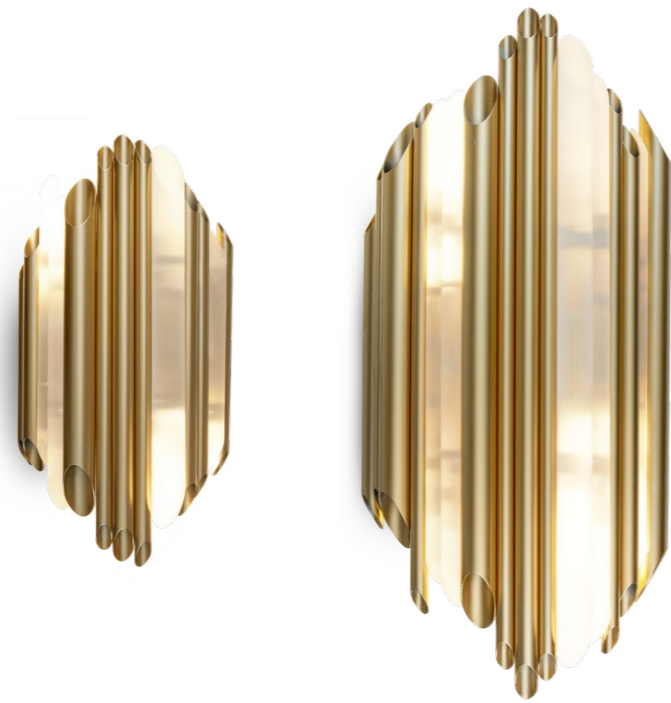

- 1. Struttura laccato oro
- 2. Diffusore plexiglass satinato

Altri colori disponibili su richiesta

Fonte luminosa - Light source
 220-240V: 2 x GU10 LED
 110V: 2 x GU10 LED

Dimmerabile, compatibile con sistemi di controllo remoto
 Dimmable, compatible with remote control system

- 1. Matt gold lacquered frame
- 2. Satin plexiglass diffuser

Other colours available on demand

Beam
MKV Design



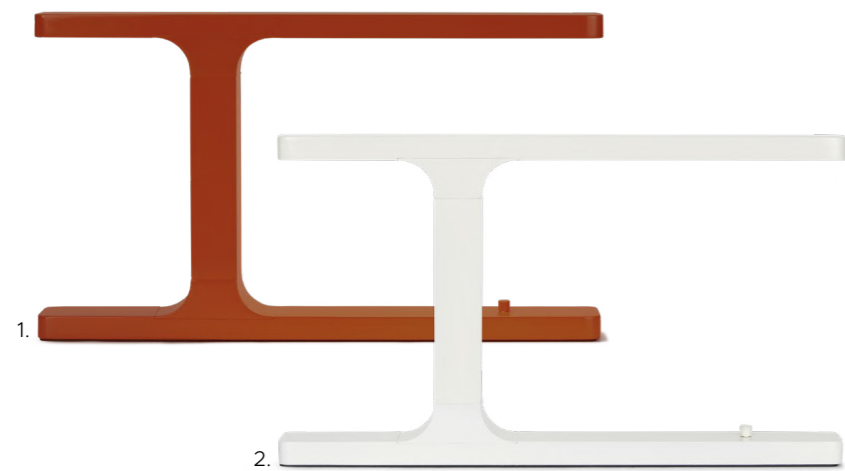

- 1. Laccato arancione scuro
- 2. Laccato bianco perla

Altri colori disponibili su richiesta

- 1. Dark orange finish
- 2. Pearl white finish

Other colours available on demand

Fonte luminosa - Light source

220-240V: 2 x 4 Strip LED - Luce orientabile (180°), tre posizioni: sinistra, destra, centrale
 110V: 2 x 4 Strip LED - adjustable light (180°), three positions: left, right and central

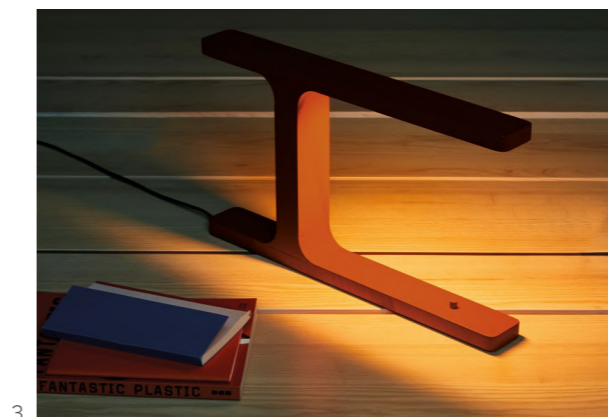

NON MUOVERE LA LAMPADA, MUOVI LA LUCE

DO NOT
 MOVE THE
 LAMP,
**MUOVE
 THE
 LIGHT**

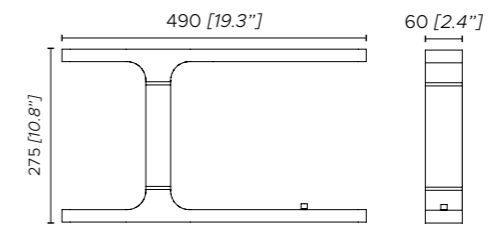

Belle
Staffan Tollgard



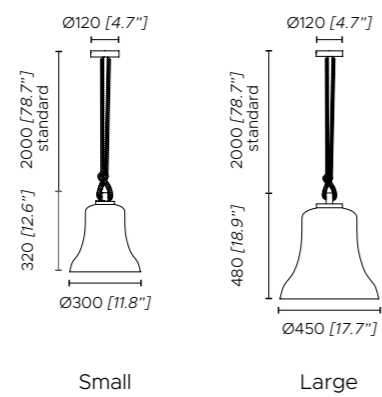

1. Ceramica bianco lucido
2. Corda in seta intrecciata grigia
3. Rosone laccato bianco
4. Ceramica grigio fango, interno avorio lucido
5. Ceramica bronzo lucido (**DELUXE**)
6. Corda in seta intrecciata marrone
7. Rosone bronzo spazzolato

Fonte luminosa - Light source
 220-240V: 1 x E27 LED
 110V: 1 x E26 LED

Dimmerabile, compatibile con sistemi di controllo remoto
 Dimmable, compatible with remote control system

1. Glossy white ceramic
2. Grey braided silk rope
3. Matte white lacquered canopy
4. Glossy mud grey coloured, ivory ceramic inside
5. Glossy bronze ceramic (**DELUXE**)
6. Brown braided silk rope
7. Satin bronze canopy

Bogotá

Massimiliano Raggi



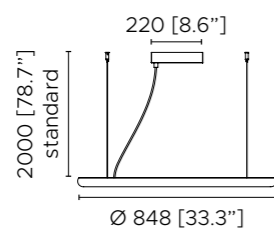

Small

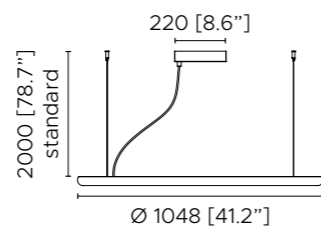

Large

1. Anello in legno tinto nero

- 2. Rivestimento diffusore in cotone bianco
- 3. Rivestimento diffusore in tessuto effetto marmo bianco Calacatta
- 4. Rivestimento diffusore in paglia di Vienna

1. Black stained wood ring

- 2. Diffuser covering in white cotton
- 3. Diffuser covering in white Calacatta marble printed fabric
- 4. Diffuser covering in Vienna straw

Fonte luminosa - Light source

220-240V: Large 1 x 43W Panel LED - Small 1 x 35W Panel LED
 110V: Large 1 x 43W Panel LED - Small 1 x 35W Panel LED

Dimmerabile / Dimmable



EFFETTO **MARMO STAMPATO** SU TESSUTO
PRINTED MARBLE EFFECT ON FABRIC



PAGLIA DI VIENNA LAVORATA A MANO
HANDCRAFT VIENNA STRAW

Calypso

Servomuto







Calypso so



1. Corda in seta intrecciata verde muschio
2. Struttura ottone satinato
3. Paralumi SO: Antigua, Guadaloupe, Martinique
4. Diffusore vetro trasparente

Fonte luminosa - Light source
 220-240V: 1 x E27 LED
 110V: 1 x E26 LED

Dimmerabile, compatibile con sistemi di controllo remoto
 Dimmable, compatible with remote control system

1. Moss green braided silk rope
2. Satin brass frame
3. Shades SO: Antigua, Guadaloupe, Martinique
4. Transparent glass diffuser

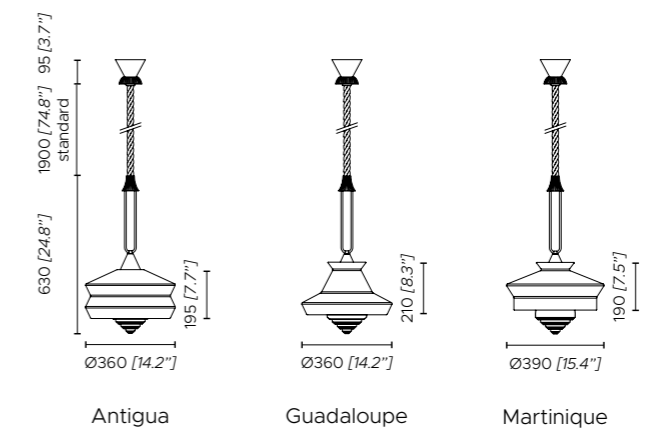





CALYPSO SO XL

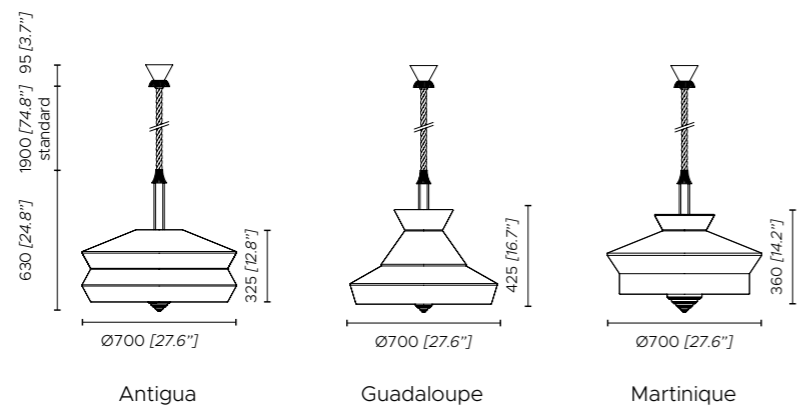

CALYPSO SO

CALYPSO SO XL



Antigua
Mint



Guadeloupe
Mint



Martinique
Yellow



Antigua
Black



Guadeloupe
Black



Martinique
Black



Antigua
Sale & Pepe



Guadeloupe
Sale & Pepe



Martinique
Building



Antigua
Mint



Guadeloupe
Sale & Pepe



Martinique
Yellow



CALYPSO
**FLOOR
+TABLE**
Servomuto

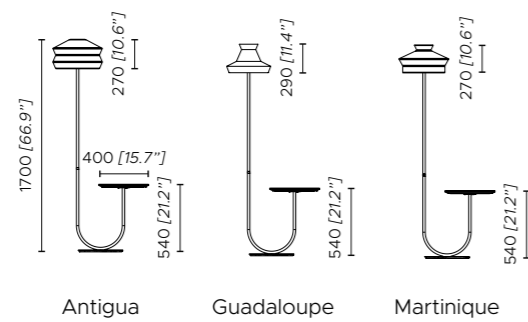

- 1. Struttura laccato nero seta opaco
- 2. Anello in ottone satinato
- 3. Marmo verde Guatemala
- 4. Pelle verde

5. **Paralumi FL:** Mint, Yellow & Building, Sale e Pepe

Fonte luminosa - Light source
 220-240V: 1 x E27 LED
 110V: 1 x E26 LED

Dimmerabile a piede
 Dimmable with foot control

- 1. Matt black silk lacquered
- 2. Satin brass ring
- 3. Green Guatemala marble
- 4. Green leather

5. **Shades FL:** Mint, Yellow & Building, Sale e Pepe



DETAILS
MATTER:
**LEATHER,
MARBLE,
BRASS**

I DETTAGLI CONTANO: PELLE, MARMO, OTTONE

Clessidra

Massimiliano Raggi



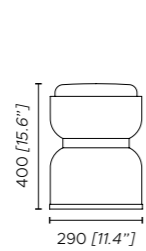

Kronos

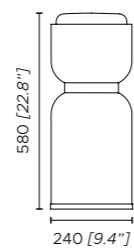

Kayros

1. Struttura "bronzo-nichel" spazzolato
2. Vetro soffiato metallizzato bronzo
3. Diffusore top superiore: vetro bianco lucido

Fonte luminosa - Light source
 220-240V: 1 x E27 LED + 1 x E27 Filament LED
 110V: 1 x E26 LED + 1 x E26 Filament LED

1. Brushed "bronze-nichel" frame
2. bronze metallized blown glass
3. Upper top diffuser: glossy white glass



Cornelia & Messalina

Massimiliano Raggi





CORNELIA & MESSALINA



1.

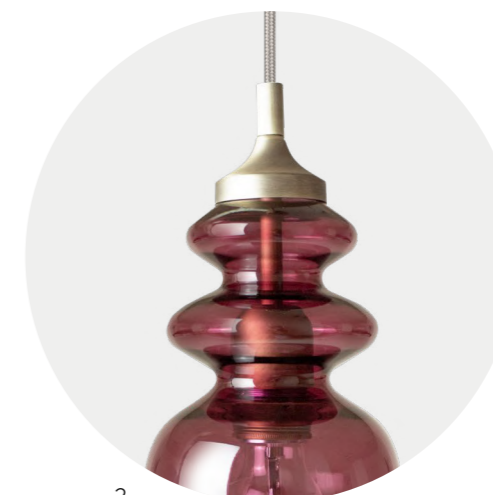

2.



3.

1. Diffusore vetro soffiato colore ambra scuro
2. Diffusore vetro soffiato colore "grigio fumé"
3. Diffusore vetro soffiato colore ametista
4. Struttura "nickel dorato" satinato

1. Hand blown glass amber colour diffuser
2. Hand blown glass "smoked grey" colour diffuser
3. Hand blown glass amethyst colour diffuser
4. Satin "golden nickel" frame

Fonte luminosa - Light source

220-240V: 1 x E27 LED
110V: 1 x E26 LED

Dimmerabile, compatibile con sistemi di controllo remoto
Dimmable, compatible with remote control system

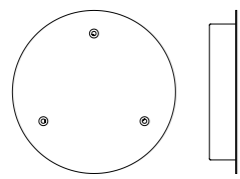

Cluster Ø300 mm
3 sospensioni
3 suspensions

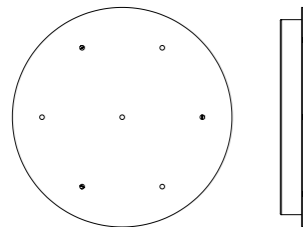

Cluster Ø500 mm
5 sospensioni
5 suspensions

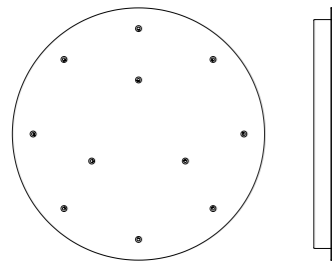

Cluster Ø700 mm
11 sospensioni
11 suspensions

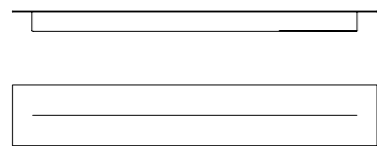

Cluster L.900 mm
Fino a 4 sospensioni
Up to 4 suspensions

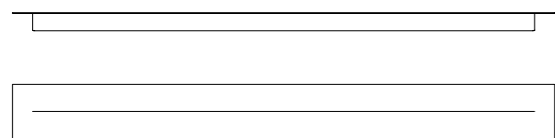

Cluster L.1500 mm
Fino a 7 sospensioni
Up to 7 suspensions

i Altre composizioni su richiesta
Other compositions available on demand



Cube

Massimiliano Raggi



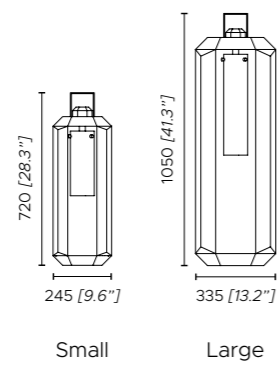

- 1. Struttura bronzo spazzolato
- 2. Interno laccato oro
- 3. Diffusore vetro pyrex rigato

- 1. Satin bronze frame
- 2. Gold lacquered inside
- 3. Striped pyrex glass diffuser

Fonte luminosa - Light source
 220-240V: 1 x E27 LED
 110V: 1 x E26 LED

Dimmerabile a piede
 Dimmable with foot control



Discus

MKV Design

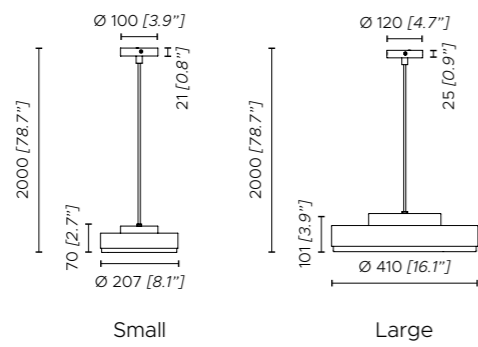
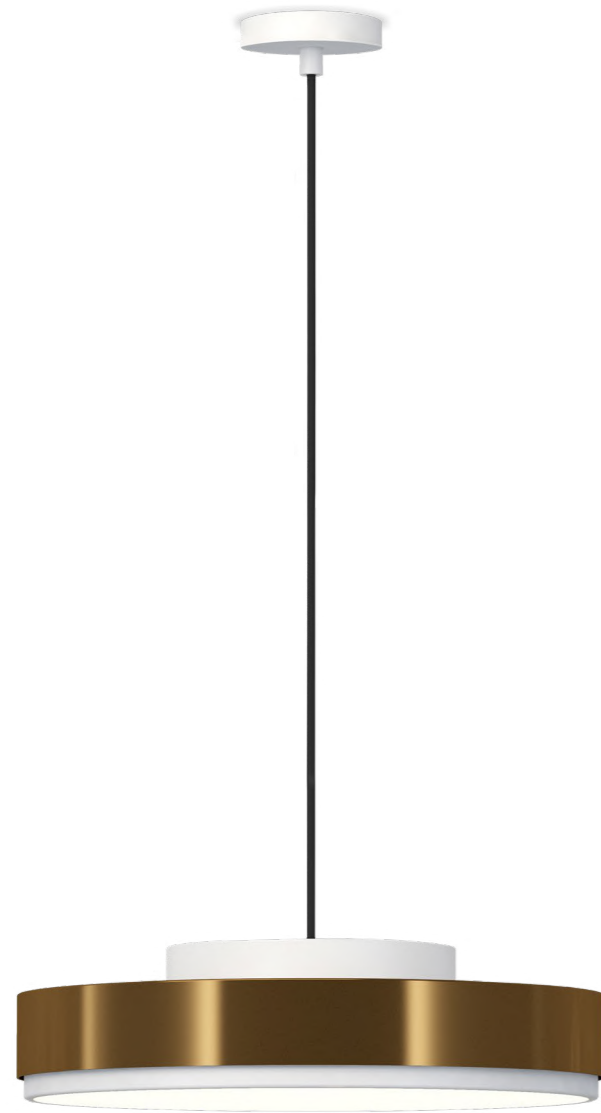

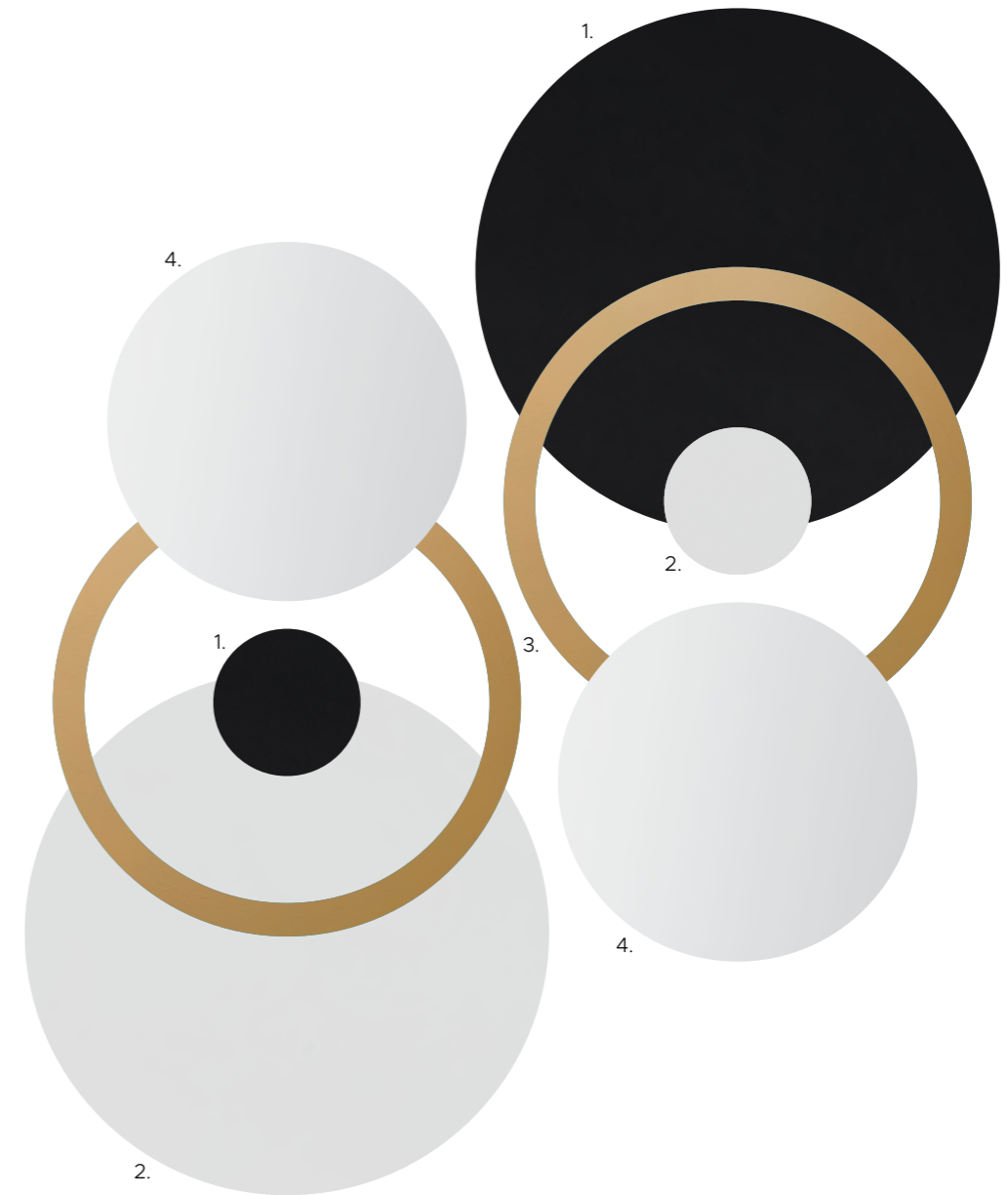
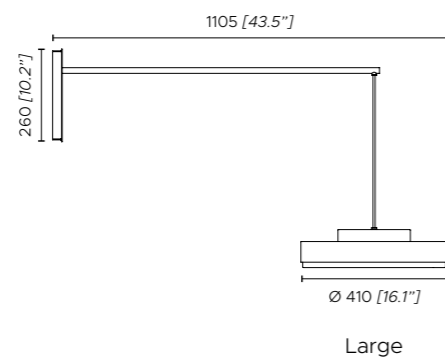

- 1. Laccato nero seta opaco
- 2. Laccato bianco opaco
- 3. Ottone semi-lucido
- 4. Diffusore plexiglass satinato

- 1. Matt black silk lacquered
- 2. Matt white lacquered
- 3. Semi-satin brass finish
- 4. Satin plexiglass diffuser

Fonte luminosa - Light source

220-240V: So-Ap-PI small 1 x 12.5W Custom LED / So-Ap-PI large 1 x 31.5W Custom LED
 110V: So-Ap-PI small 1 x 12.5W Custom LED / So-Ap-PI large 1 x 31.5W Custom LED

Dimmerabile, compatibile con controllo di sistema remoto
 Dimmable, compatible with remote control system

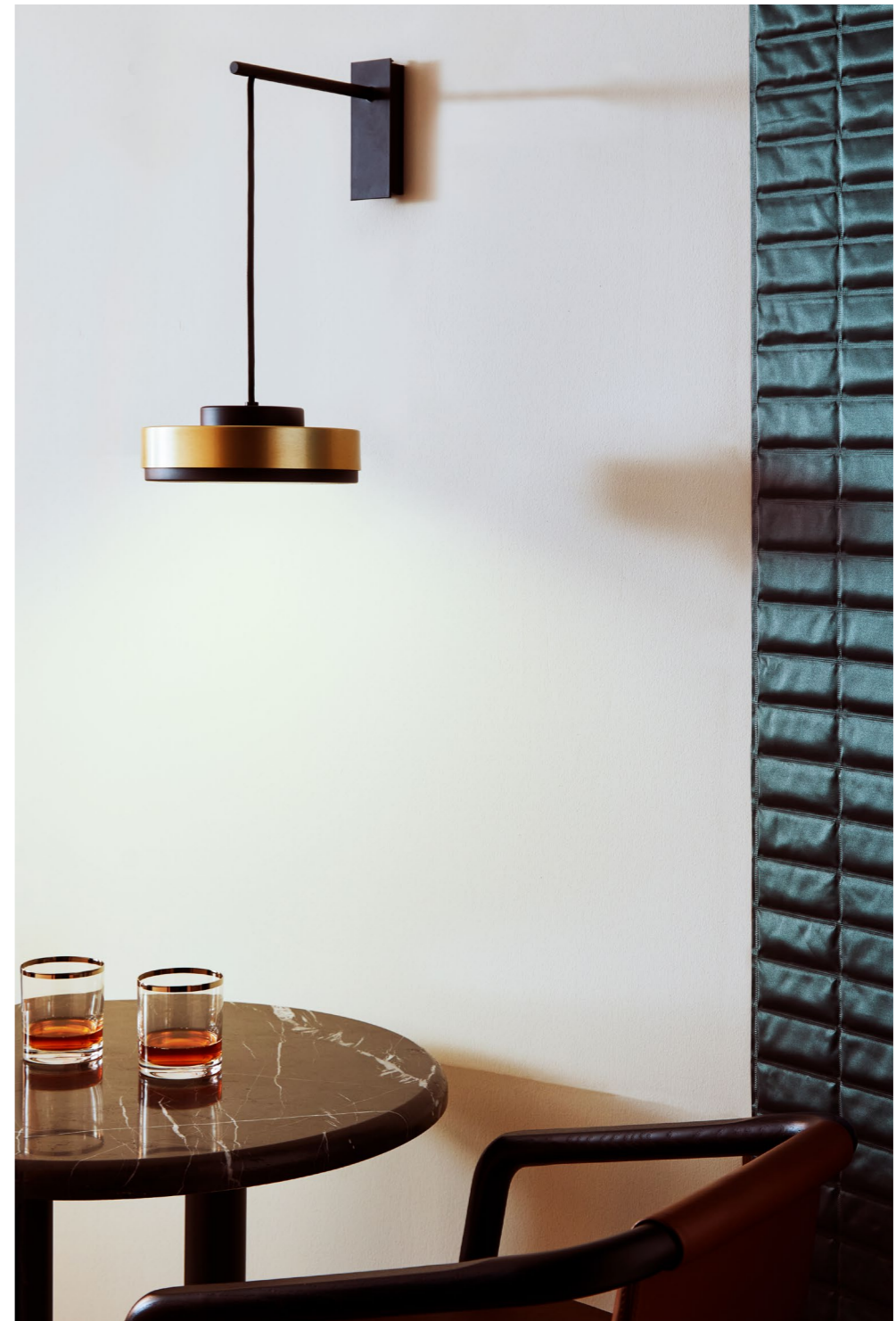
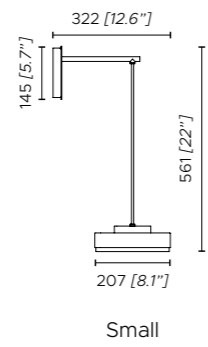

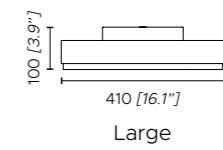
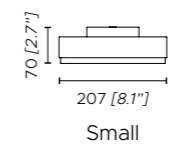

Dorian
Marcello Colli



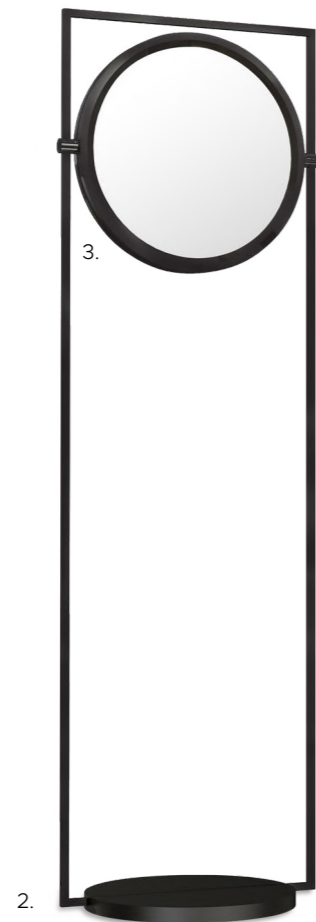

- 1. Struttura bronzo spazzolato chiaro opaco
- 2. Struttura laccato nero seta opaco
- 3. Diffusore: specchio fumè, pexiglass con serigrafia a nido d'ape

- 1. Matte light satin bronze frame
- 2. Matte black silk lacquered
- 3. Diffuser: Smoked coloured mirror, plexiglass with honeycomb effect screen printing

Fonte luminosa - Light source

220-240V: FI 1 x 55W Custom LED plate / So small 1 x 17W Custom LED plate
 110V: FI 1 x 55W Custom LED plate / So small 1 x 17W Custom LED plate

So - dimmerabile, compatibile con sistemi di controllo remoto / FI - dimmerabile a piede
 So - dimmable, compatible with remote control system / FI - dimmable with foot control

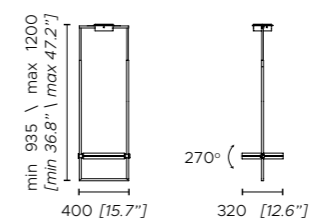

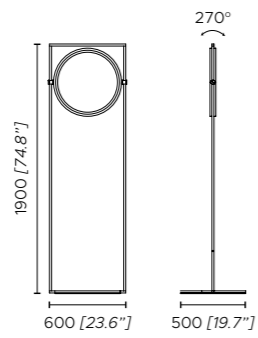

Eclisse 2.0

Massimiliano Raggi





1. Rosone bronzo spazzolato

2. Anello grande in legno bronzo scuro
3. Anelli piccoli in legno bronzo chiaro

4. Dischi diffusori in alicrite effetto alabastro

Fonte luminosa - Light source

220-240V: 1 x 25W Panel LED + 1 x 15W Panel LED
110V: 1 x 25W Panel LED + 1 x 15W Panel LED

Dimmerabile, compatibile con sistemi di controllo remoto
Dimmable, compatible with remote control system

1. Satin bronze canopy

2. Larger ring in dark bronze painted wood
3. Smaller rings in light bronze painted wood

4. Alicrite diffusing discs with alabaster effect

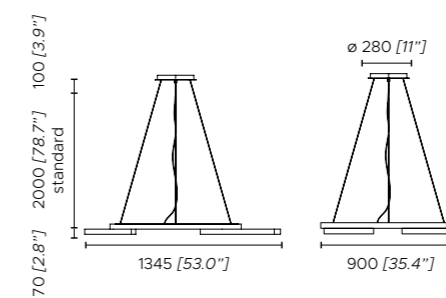

Emma
Contardi Studio



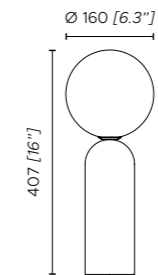

1. Marmo verde Guatemala
2. Marmo bianco Calacatta
3. Diffusore sfera bianca opale

1. Green Guatemala marble
2. White Calacatta marble
3. Opal white globe diffuser

Fonte luminosa - Light source
 220-240V: 1 x G9 LED
 110V: 1 x G9 LED

Ap, pl - dimmerabile, compatibile con sistemi di controllo remoto / Ta - dimmerabile su cavo
 Ap, pl - dimmable, compatible with remote control system / Ta - dimmable on the cable

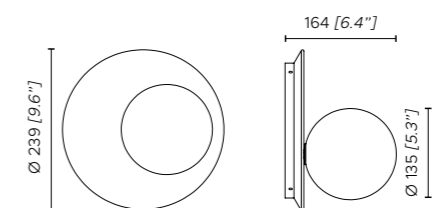
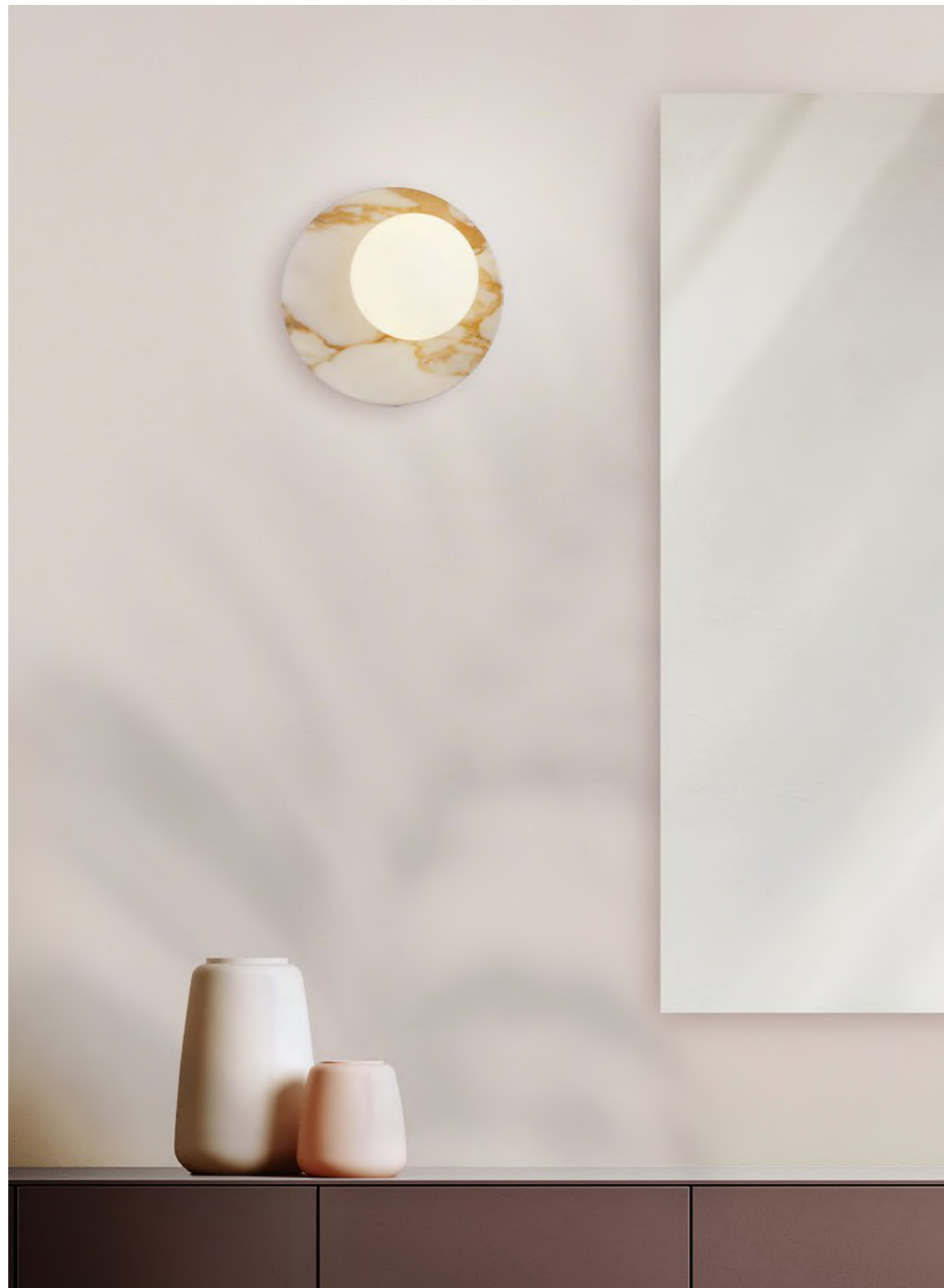

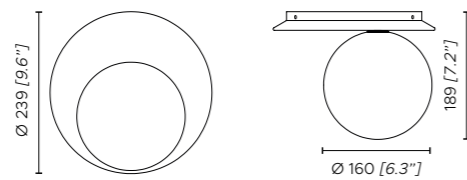

Flexiled

King & Roselli



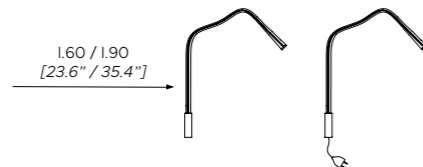

- 1. Base laccato nero seta opaco
- 2. Base bronzo spazzolato
- 3. Base nickel satinato
- 4. Maglia d'acciaio intrecciato
- 5. Pelle avorio
- 6. Pelle marrone testa di moro
- 7. Pelle nera

- 1. Matt black silk lacquered base
- 2. Satin bronze base
- 3. Satin nickel base
- 4. Braided steel mesh
- 5. Ivory leather
- 6. Dark brown leather
- 7. Black leather

Fonte luminosa - Light source

220-240V: Ap 1 x 3W Custom LED / FI 1 x 7W Custom LED
 110V: Ap 1 x 3W Custom LED / FI 1 x 7W Custom LED

FI - dimmerabile a piede
 FI - dimmable with foot control

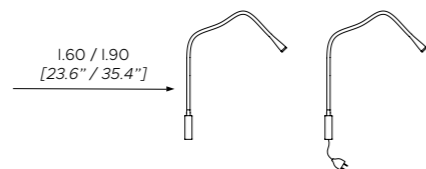
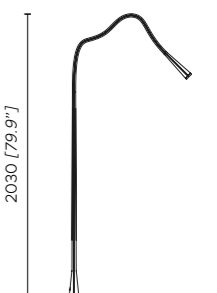



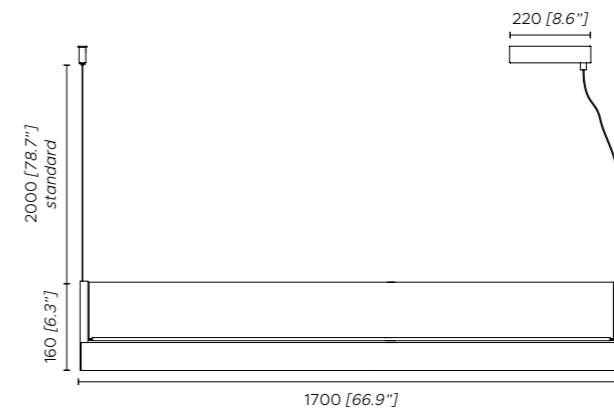
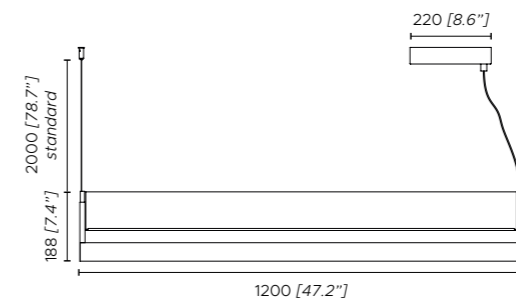
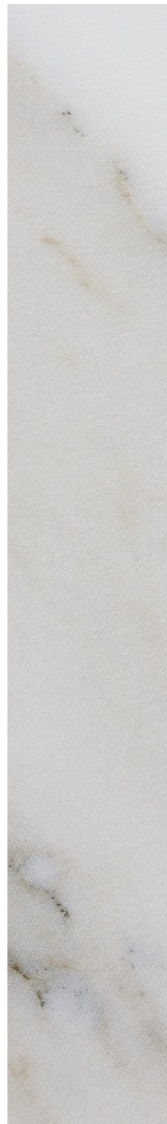



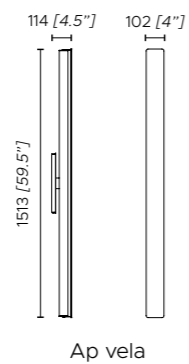
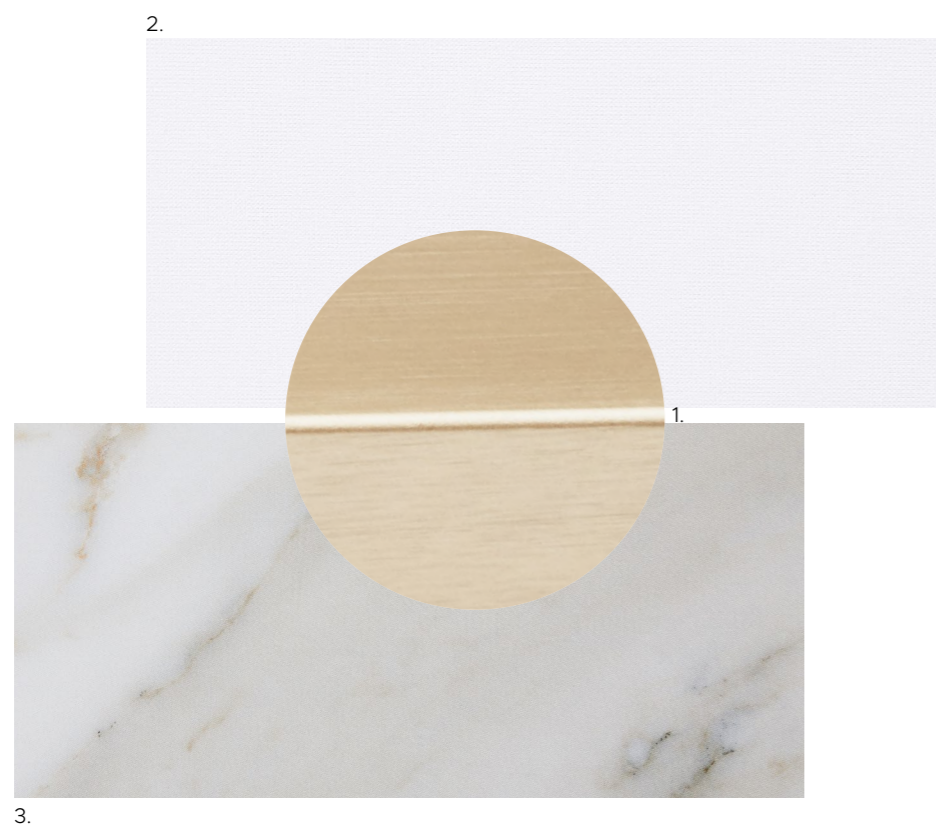

- 1. "Nickel dorato" satinato
- 2. Cotone bianco
- 3. Tessuto effetto marmo bianco Calacatta

- 1. "Golden nickel" finish
- 2. White cotton
- 3. White Calacatta marble printed fabric

Fonte luminosa - Light source

220-240V: Ap-So I.120 1 x 45W Strip LED / So I.150 1 x 60W Strip LED / Picture 1 x 12W Strip LED
110V: Ap-So I.120 1 x 45W Strip LED / So I.150 1 x 60W Strip LED / Picture 1 x 12W Strip LED

Dimmerabile, compatibile con sistemi di controllo remoto
Dimmable, compatible with remote control system



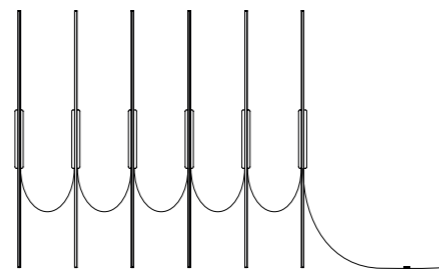
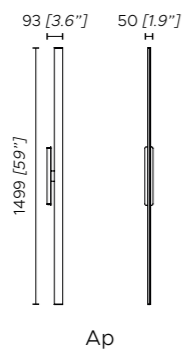

Composizione esempio Fly ap (max. 6 lampade) /
Example of Fly ap modular system (max. 6 lamps)



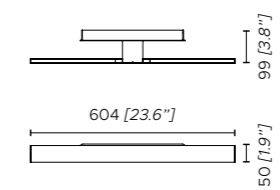

G+T

Jan Van Lierde



404 [15.9"]
2000 [78.7"] 80 [3.1"]
standard
50 [1.9"]



VERSIONE CABLATA / WIRED VERSIONE

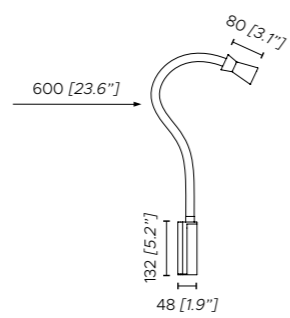

- 1. Bronzo rame lucido
- 2. Nickel lucido
- 3. Cuoio intrecciato marrone testa di moro
- 4. Laccato nero seta opaco

- 1. Polished copper bronze
- 2. Polished nickel
- 3. Dark brown braided leather
- 4. Matt black silk lacquered

Fonte luminosa - Light source

220-240V: Ap-Battery 1 x 2W Custom LED / Reading-So 1 x 3W Custom LED
 110V: Ap-Battery 1 x 2W Custom LED / Reading-So 1 x 3W Custom LED

Battery - dimmerabile, comando a tre livelli
 Battery - dimmable, three level control



VERSIONE **A BATTERIA** / **BATTERY OPERATED VERSION**

TABLE FIXING ACCESSORY

FISSAGGIO PER **TAVOLO**

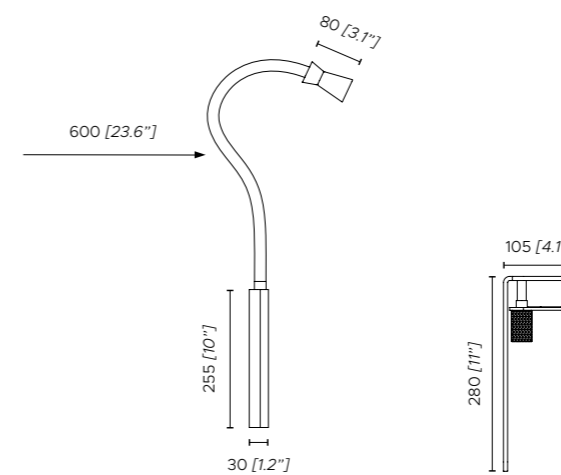

Dimmerabile: 3 intensità
Dimmable: 3 steps

VERSIONE A BATTERIA / BATTERY OPERATED VERSION



WALL FIXING ACCESSORY

FISSAGGIO PER PARETE

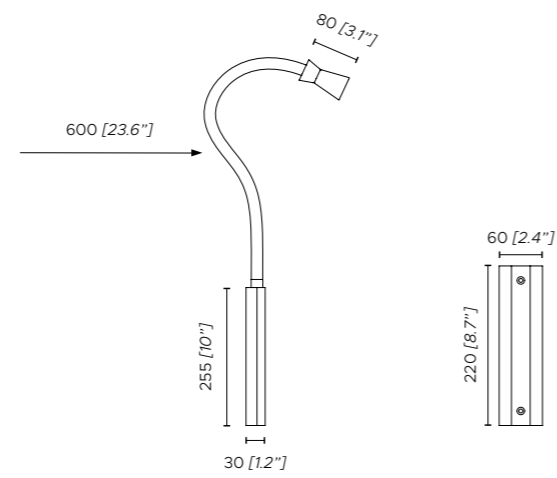

Dimmerabile: 3 intensità
Dimmable: 3 steps





VERSIONE **A BATTERIA** / **BATTERY OPERATED VERSION**

SEATS & SOFA FIXING ACCESSORY

FISSAGGIO PER **POLTRONE E DIVANI**

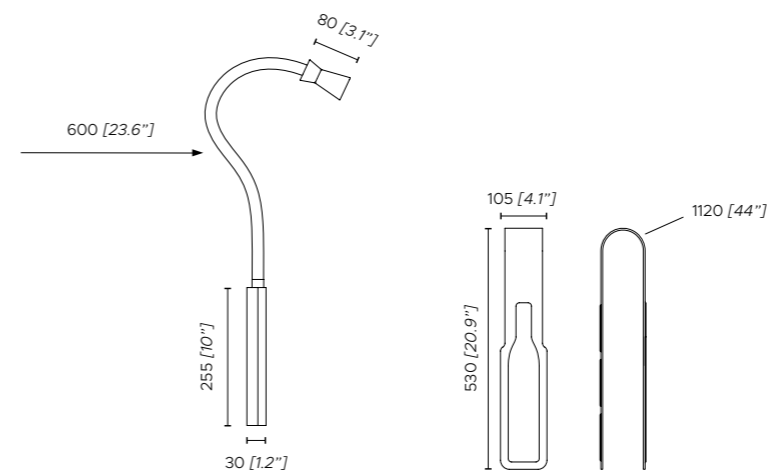

Dimmerabile: 3 intensità
Dimmable: 3 steps

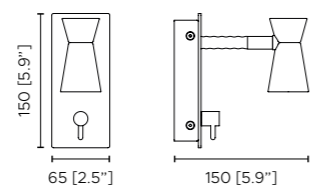

Kubric

Massimiliano Raggi





- 1. Bronzo spazzolato
- 2. Vetro bronzo lucido con interno oro

ⓘ Altri colori su richiesta

Fonte luminosa - Light source
 220-240V: 1 5W Custom LED
 110V: 1 x 5W Custom LED

Dimmerabile, compatibile con sistemi di controllo remoto
 Dimmable, compatible with remote control system

- 1. Satin bronze
- 2. Polished bronze glass with gold painted inside

ⓘ Other colours available on demand

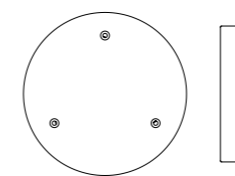

Cluster Ø300 mm
 3 sospensioni
 3 suspensions

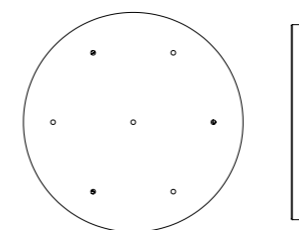

Cluster Ø500 mm
 5 sospensioni
 5 suspensions

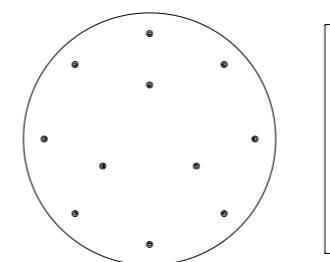

Cluster Ø700 mm
 11 sospensioni
 11 suspensions

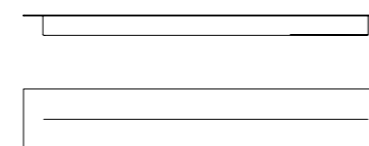

Cluster L.900 mm
 Fino a 6 sospensioni
 Up to 6 suspensions

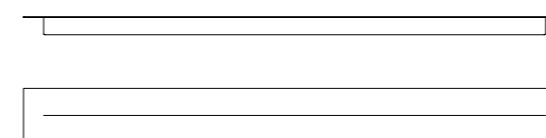

Cluster L.1500 mm
 Fino a 10 sospensioni
 Up to 10 suspensions

ⓘ Altre composizioni su richiesta
 Other compositions available on demand

Manhattan

Contardi Studio



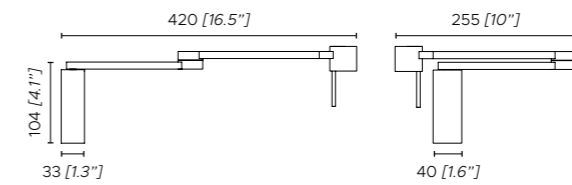
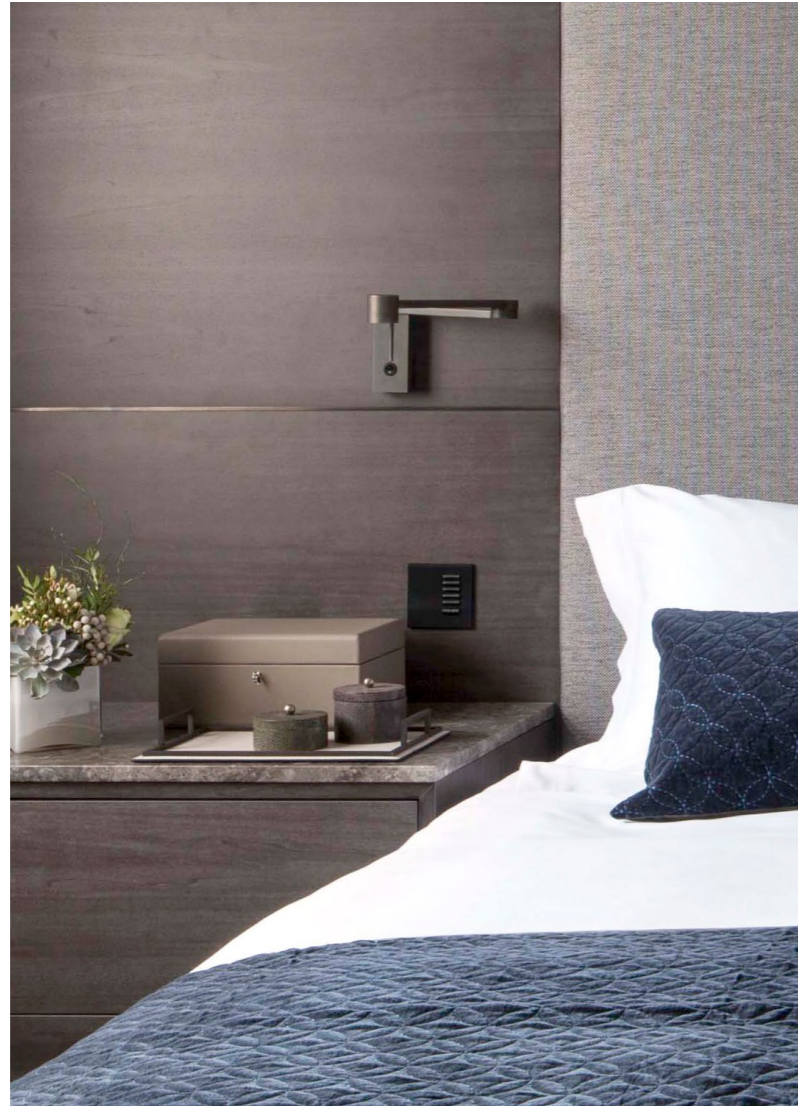

APRI / OPEN

RUOTA / TURN

CHIUDI / CLOSE

- 1. Bronzo spazzolato
- 2. Nickel satinato

- 1. Satin bronze
- 2. Satin nickel

Fonte luminosa - Light source
 220-240V: 1 3W Custom LED
 110V: 1 x 3W Custom LED



Melanocetus

Tristan Auer

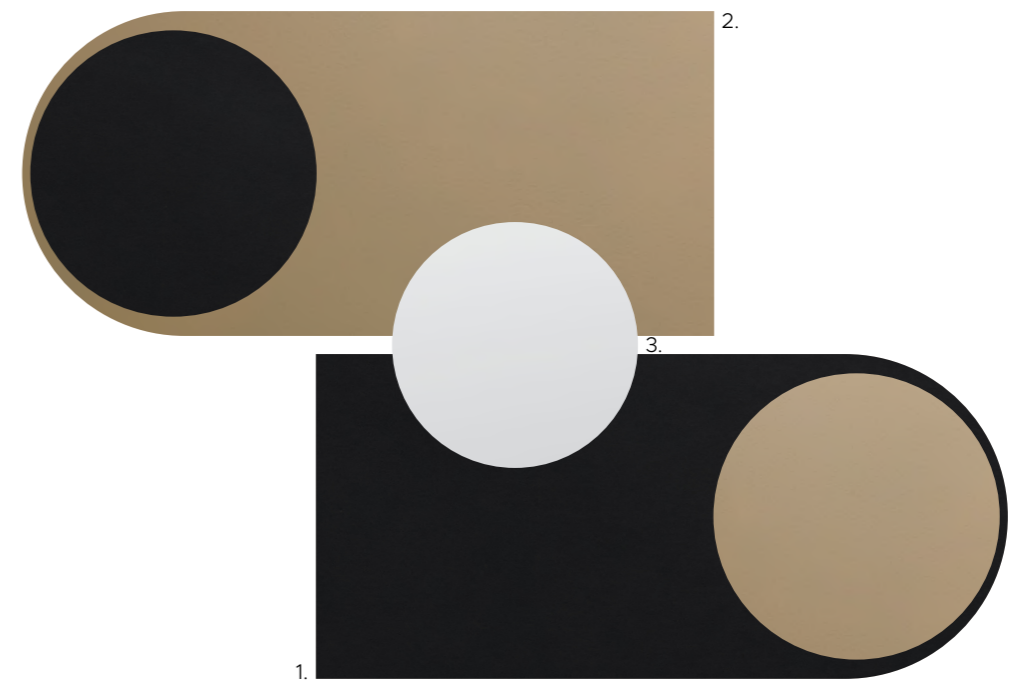

1. Nero opaco con dettagli oro satinato
2. Oro satinato con dettagli nero opaco
3. Diffusore: plexiglass satinato

1. Matt black lacquered with satin gold details
2. Satin gold finish with matt black lacquered details
3. Diffuser: satin plexiglass

Fonte luminosa - Light source

220-240V: PI 2 x 7.5W GU10 LED / PI Double 4 x 7.5W GU10 LED
 110V: PI 2 x 7.5W GU10 LED / PI Double 4 x 7.5W GU10 LED

Dimmerabile, compatibile con sistemi di controllo remoto
 Dimmable, compatible with remote control system

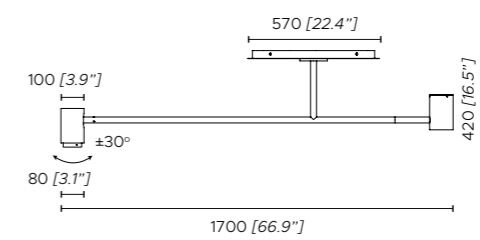

PI

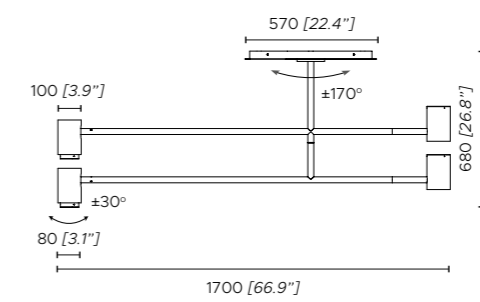

PI double

Mikado
Massimiliano Raggi



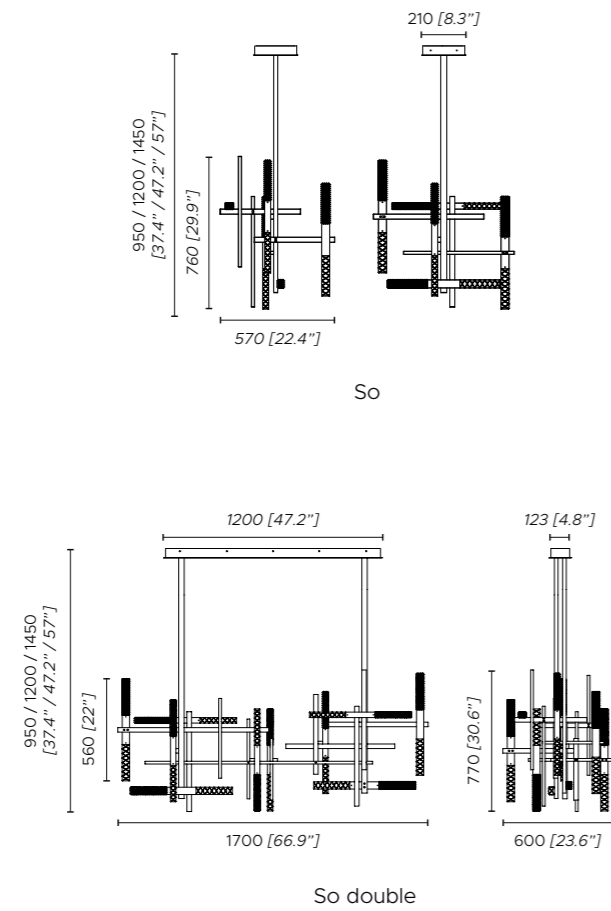

Fonte luminosa - Light source

220-240V: So 10 x 4W Custom LED / So double 20 x 4W Custom LED
 110V: So 10 x 4W Custom LED / So double 20 x 4W Custom LED

So, so double - dimmerabile, compatibile con sistemi di controllo remoto
 So, so double - dimmable, compatible with remote control system

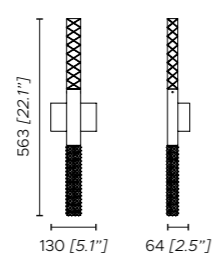

Ap solo/2

- 1. Ottone satinato Mikado
- 2. Diffusore finitura inciso
- 3. Diffusore finitura prismatic

Fonte luminosa - Light source
 220-240V: Ap solo/2 x 4W Custom LED
 110V: Ap solo/2 x 4W Custom LED

Dimmerabile, compatibile con sistemi di controllo remoto
 Dimmable, compatible with remote control system

- 1. Mikado satin brass
- 2. Engraved finish diffuser
- 3. Prismatic finish diffuser

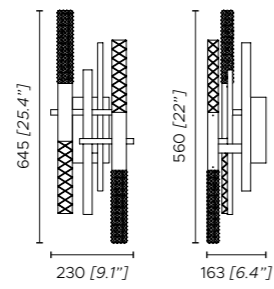
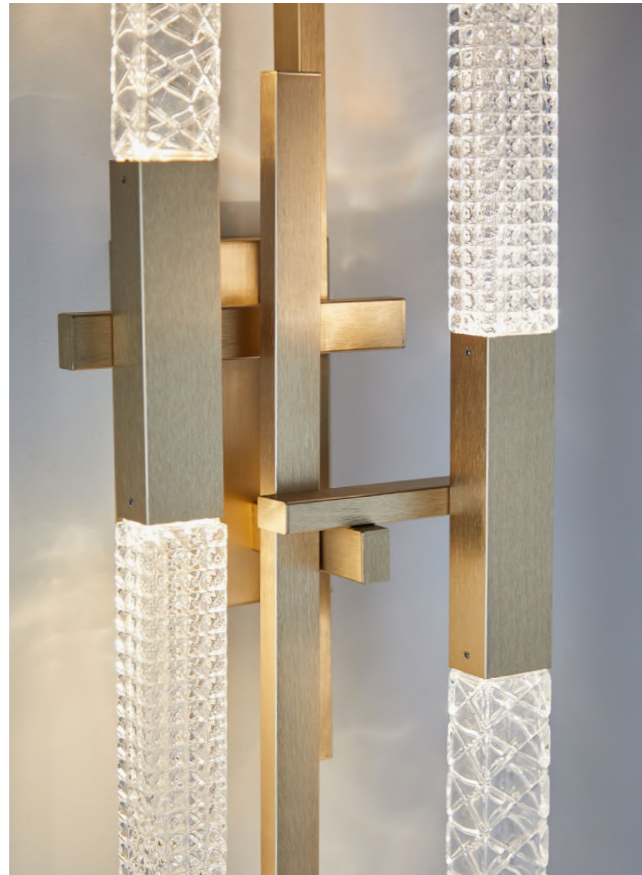

Ap

Fonte luminosa - Light source
220-240V: Ap 4 x 4W Custom LED
110V: Ap 4 x 4W Custom LED

Dimmerabile, compatibile con sistemi di controllo remoto
Dimmable, compatible with remote control system

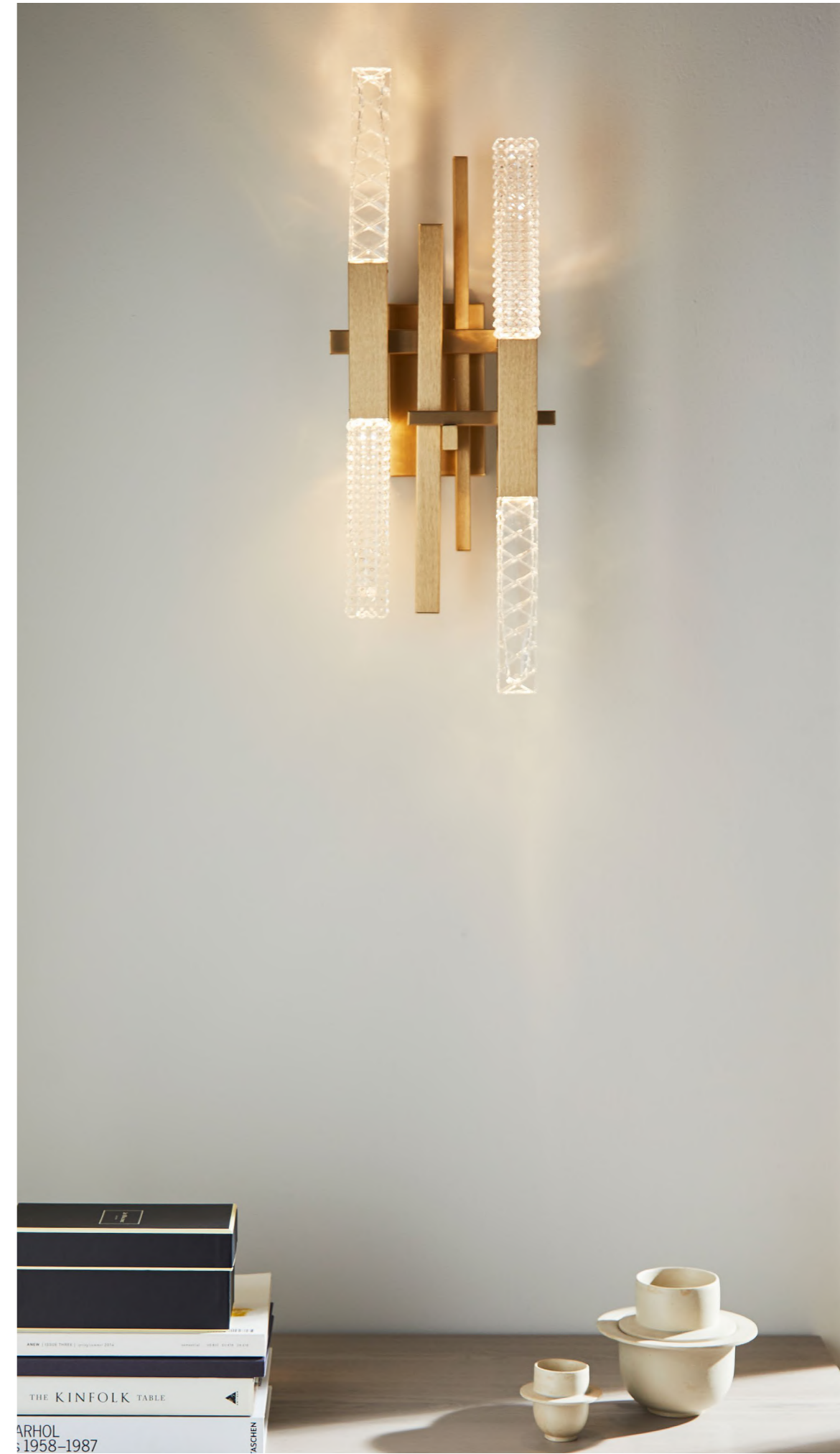

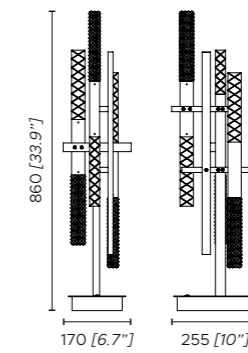

Fonte luminosa - Light source

220-240V: Ta 6 x 4W Custom LED

110V: Ta 6 x 4W Custom LED

Dimmerabile su base a tre livelli d'intensità (100 - 70 - 30%)

Dimmable on the base with three intensity levels (100 - 70 - 30%)

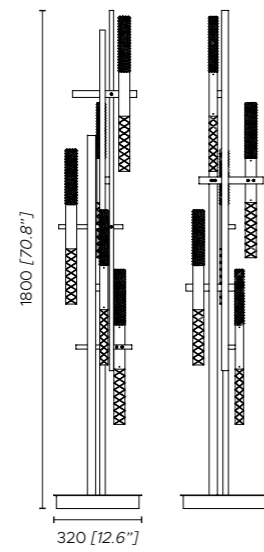

Fonte luminosa - Light source
 220-240V: FI 10 x 4W Custom LED
 110V: FI 10 x 4W Custom LED

Dimmerabile a piede
 Dimmable with foot control

Muse Lantern

Tristan Auer





- 1. Struttura bronzo spazzolato
- 2. Maniglia in seta intrecciata color miele
- 3. Acrilico color ambra

- 1. Satin bronze frame
- 2. Honey-coloured braided silk handle
- 3. Amber finish acrylic

Fonte luminosa - Light source
 220-240V: 1 x E27 Classic Deco LED
 110V: 1 x E26 Classic Deco LED

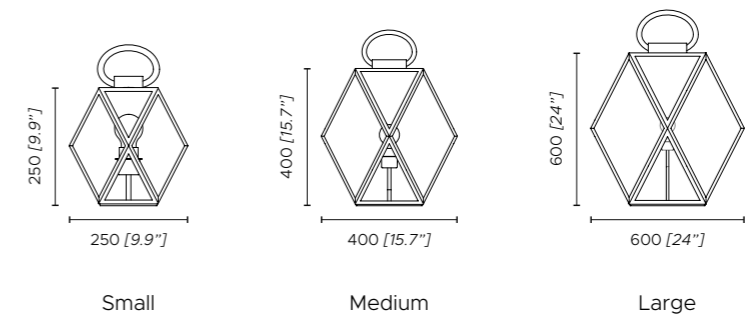

Ongo

Jessica Corr for Tzelan



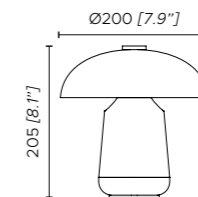

1. Laccato arancione scuro
2. Laccato oro satinato
3. Laccato argento caldo
4. Vetro bianco acidato

1. Dark orange lacquered
2. Satin gold lacquered
3. Dark silver lacquered
4. White etched glass

Fonte luminosa - Light source
 220-240V: 1 x 2W Custom LED
 110V: 1 x 2W Custom LED

Dimembrabile, due intensità
 Dimmable, two intensity levels

Solitario

Marcello Colli & Maurizio Di Mauro





1. Bronzo spazzolato chiaro opaco
2. Laccato nero seta opaco

3. Sfera vetro acidato $\varnothing 120 / 4.7''$
4. Sfera vetro acidato $\varnothing 200 / 7.9''$
5. Lente flood

1. Matt light satin bronze
2. Matt black lacquered silk

3. Acid-etched glass sphere $\varnothing 120 / 4.7''$
4. Acid-etched glass sphere $\varnothing 200 / 7.9''$
5. Flood lens

Fonte luminosa - Light source

220-240V: PI-So 1 x 7.5W GU10 LED / Ap mini IP44 1 x 7W G9 LED / Ap mini 1 x E27 LED
110V: PI-So 1 x 7.5W GU10 LED / Ap mini IP44 1 x 7W G9 LED / Ap mini 1 x E26 LED

Dimmerabile, compatibile con sistemi di controllo remoto
Dimmable, compatible with remote control system

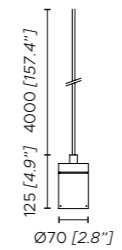
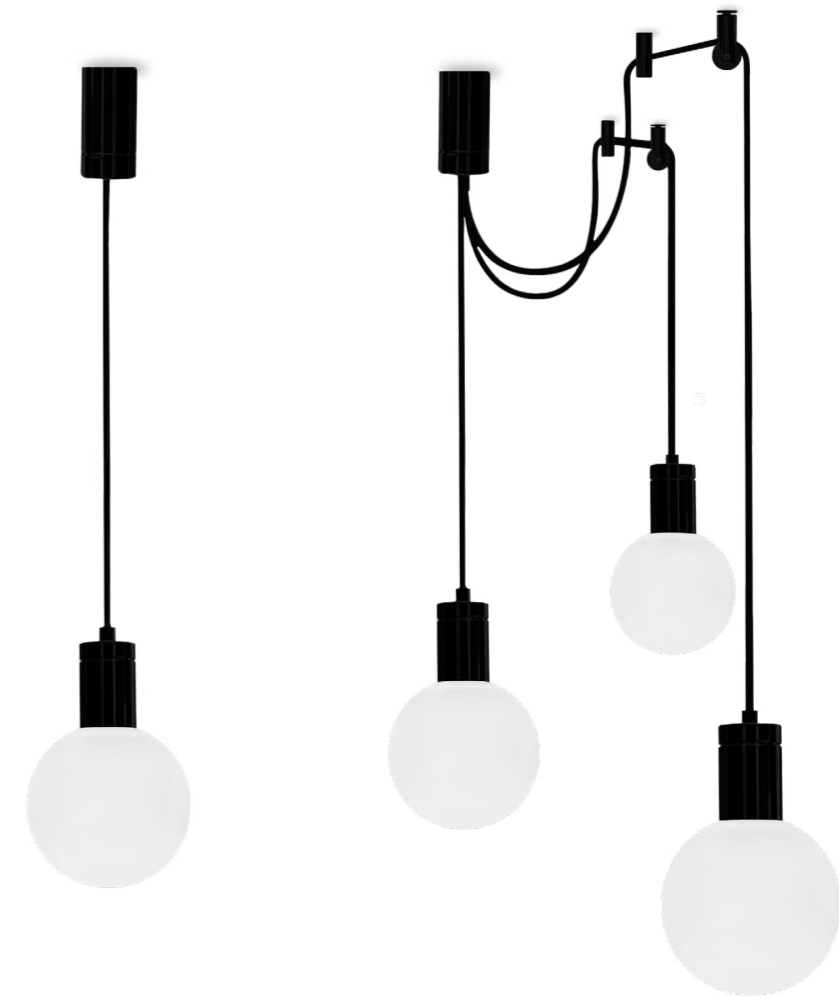



Composizioni / Compositions

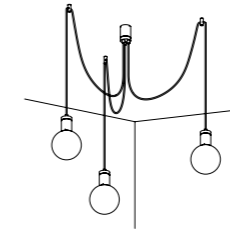

- 1 x Rosone 3x / Canopy 3x
- 3 x Solitario So
- 3 x Kit accessori / Accessories
(Carrucola / Blocca cavo)
(Pulley / Cable clamp)
- 3 x Sfere Ø200 / Spheres Ø200 / Ø7,9"

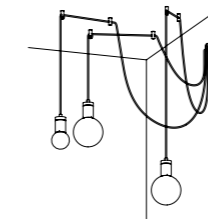

- 1 x Rosone 3x / Canopy 3x
- 3 x Solitario So
- 6 x Kit accessori / Accessories
(Carrucola / Blocca cavo)
(Pulley / Cable clamp)
- 1 x Sfera Ø120 / Sphere Ø120 / Ø4,7"
- 2 x Sfere Ø200 / Spheres Ø200 / Ø7,9"

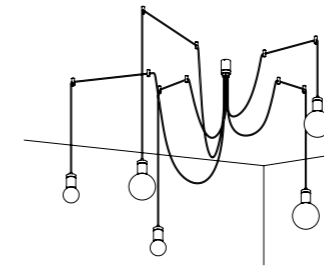

- 1 x Rosone 5x / Canopy 5x
- 5 x Solitario So
- 10 x Kit accessori / Accessories
(Carrucola / Blocca cavo)
(Pulley / Cable clamp)
- 2 x Sfere Ø120 / Spheres Ø120 / Ø4,7"
- 3 x Sfere Ø200 / Spheres Ø200 / Ø7,9"

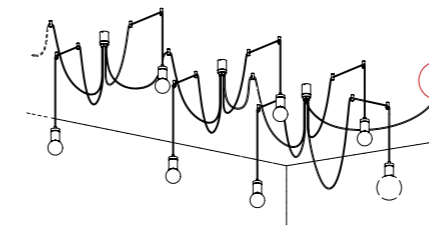

Una sola uscita elettrica per composizioni potenzialmente infinite
Just one electrical output for potentially unlimited compositions

Rosone / Canopy

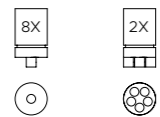

8 x Solitario So

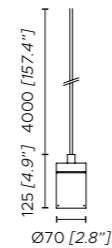

Accessori / Accessories

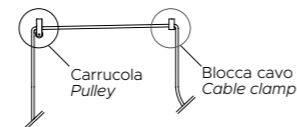

Sfere / Spheres

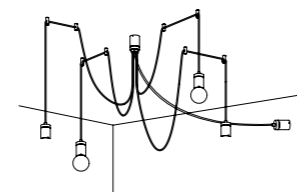
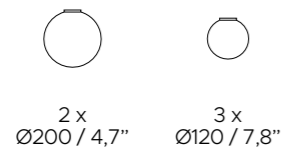

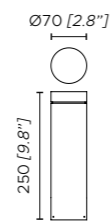
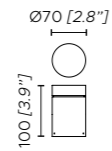

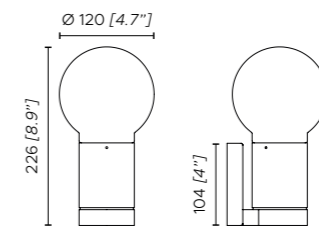

Ap mini

Stardust

Marcello Colli & Maurizio Di Mauro





- 1. Bronzo spazzolato chiaro opaco
- 2. Vetro bianco satinato

- 1. Matt light satin bronze
- 2. Satin white glass

Fonte luminosa - Light source

220-240V: 1 x E27 + 20 x 3W Custom LED
 110V: 1 x E26 + 20 x 3W Custom LED

Dimmerabile, compatibile con sistemi di controllo remoto - CUSTOM LED, non dimmerabili
 Dimmable, compatible with remote control system - CUSTOM LED, not dimmable

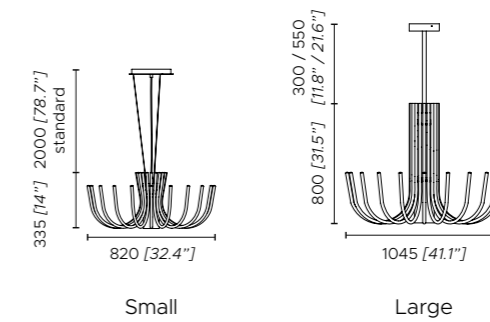

Stick
Studiopepe



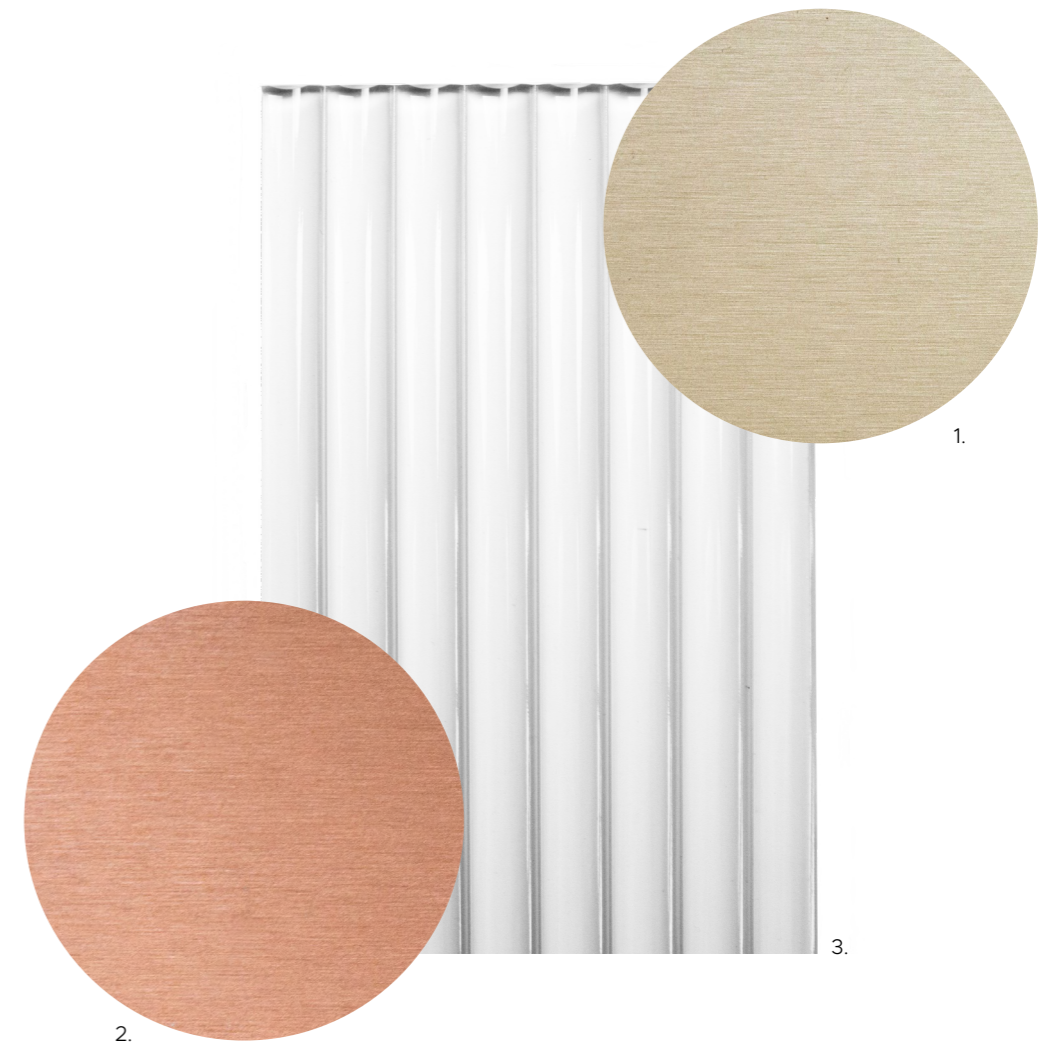
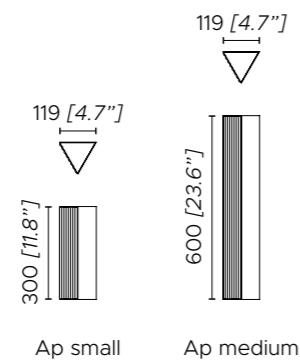

- 1. "Nickel dorato" satinato
- 2. Rame satinato
- 3. Diffusore rigato

- 1. Satin "Golden nickel" finish
- 2. Satin copper
- 3. Ribbed diffuser

① Altre finiture disponibili su richiesta

① Other finishes available on demand

Fonte luminosa - Light source

220-240V: Ap small 1 x PCB LED 13.5W / Ap medium 2 x PCB LED 13.5W
 110V: Ap small 1 x PCB LED 13.5W / Ap medium 2 x PCB LED 13.5W

Dimmerabile su richiesta, compatibile con sistemi di controllo remoto
 Dimmable on request, compatible with remote control systems

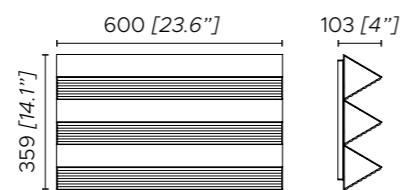

Ap trio



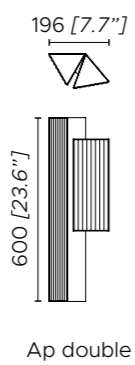

Ap double

**Fonte luminosa - Light source**

220-240V: Ap double 3 x PCB LED 13.5W / Ap trio 6 x PCB LED 13.5W
 110V: Ap double 3 x PCB LED 13.5W / Ap trio 6 x PCB LED 13.5W

Dimmerabile su richiesta, compatibile con sistemi di controllo remoto
 Dimmable on request, compatible with remote control systems

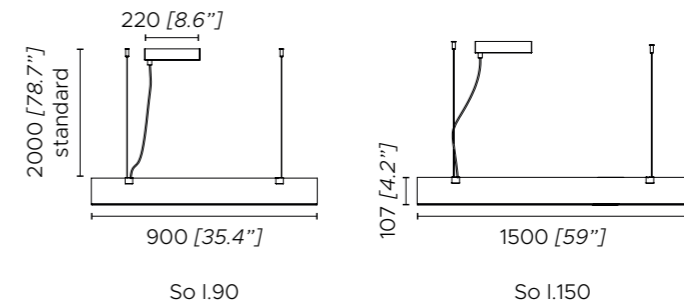

Fonte luminosa - Light source

220-240V: So small 3 x PCB LED 13.5W / So large 5 x PCB LED 13.5W
110V: So small 3 x PCB LED 13.5W / So large 5 x PCB LED 13.5W

Dimmerabile su richiesta, compatibile con sistemi di controllo remoto
Dimmable on request, compatible with remote control systems

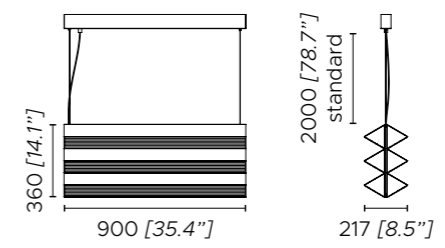

So trio

Fonte luminosa - Light source

220-240V: So trio 18 x PCB LED 13.5W

110V: So trio 18 x PCB LED 13.5W

Dimmerabile su richiesta, compatibile con sistemi di controllo remoto
Dimmable on request, compatible with remote control systems

Tenebra

Jan Van Lierde





VERSIONE A BATTERIA,
SENZA ROSONE
**BATTERY OPERATED
VERSION, WITHOUT CANOPY**

VERSIONE CABLATA,
CON ROSONE
**WIRED VERSION,
WITH CANOPY**

- 1. Laccato nero seta opaco
- 2. Laccato oro rosa
- 3. Laccato argento

- 1. Matt black silk lacquered
- 2. Rose gold lacquered
- 3. Silver lacquered

Fonte luminosa - Light source
220-240V: 1 x 3W LED
110V: 1 x 3W LED

Battery - dimmerabile / dimmable

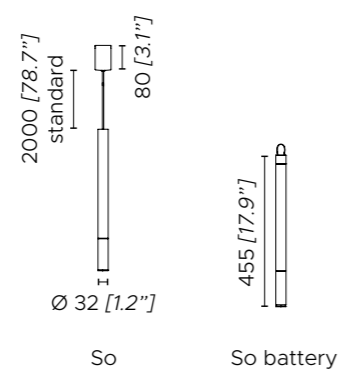

So

So battery



1.



2.



3.

- 1. Diffusore "lente grigio"
- 2. Diffusore Venezia ambra
- 3. Diffusore Crystal Macedonia

Fonte luminosa - Light source
 220-240V: 1 x 3W LED
 110V: 1 x 3W LED

Battery - dimmerabile / dimmable

- 1. "Grey lens" diffuser
- 2. Venezia Amber diffuser
- 3. Crystal Macedonia diffuser

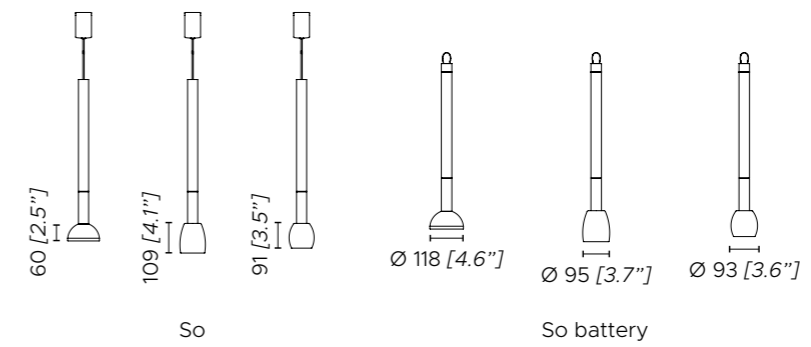

Treasure

Massimiliano Raggi



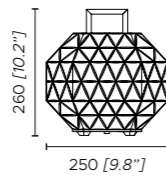

- 1. Nickel lucido
- 2. Cristallo inciso

- 1. Polished nickel
- 2. Engraved crystal

Fonte luminosa - Light source
 220-240V: 1 x E27 LED
 110V: 1 x E26 LED

Interruttore dimmerabile su cavo
 Dimmable switch on the cable

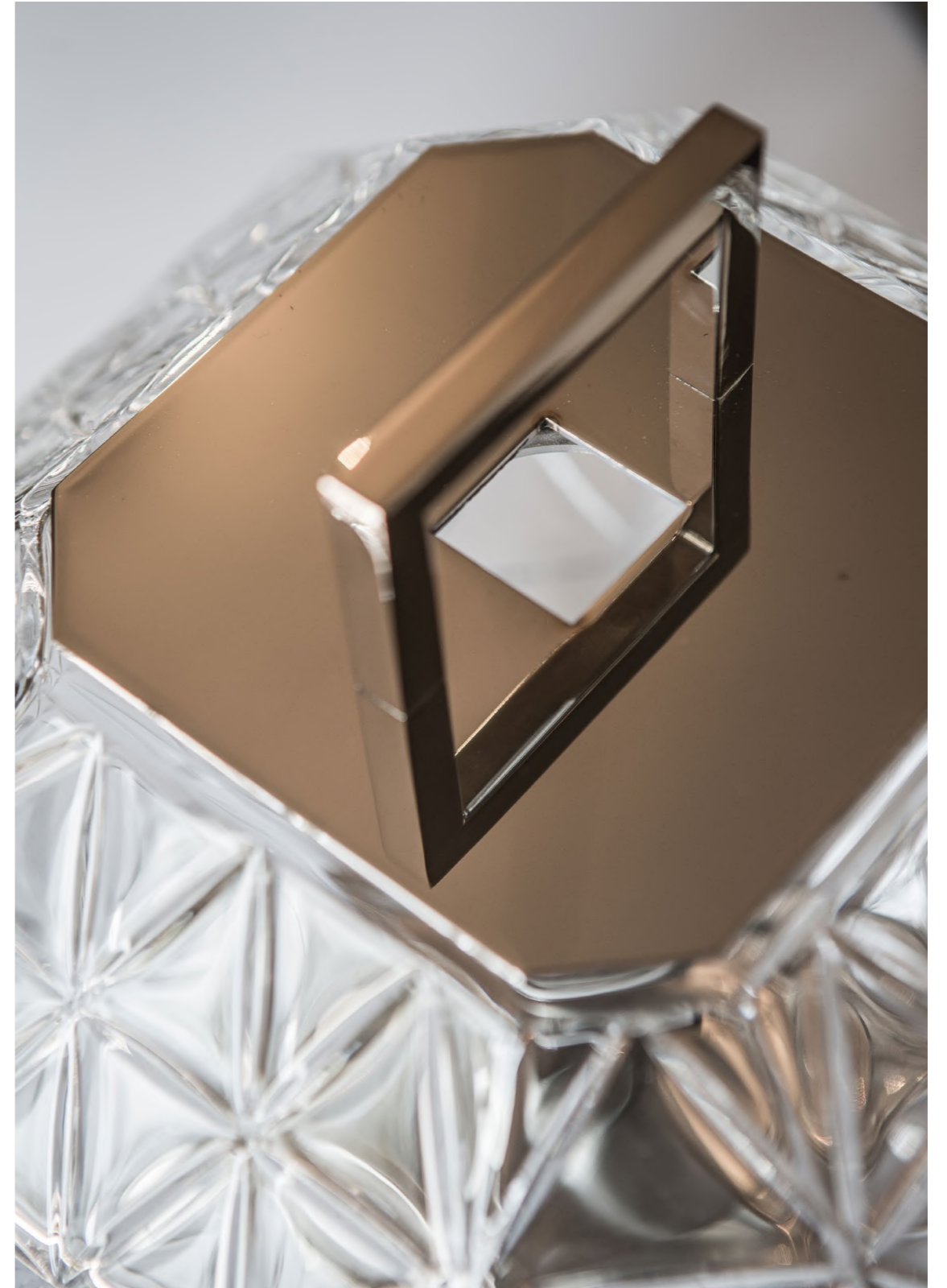

Up

Massimiliano Raggi



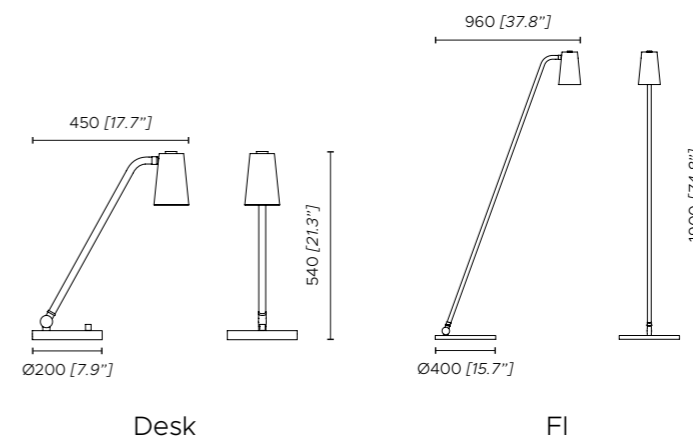

1. "Bronzo-nickel" spazzolato
2. Cavo in seta color arancione scuro
3. Diffusore esterno: "bronzo-nickel" spazzolato
4. Diffusore interno: crema lucido

1. Brushed "bronze-nickel"
2. Dark orange silk rope
3. Outside diffuser: brushed "bronze-nickel"
4. Inside diffuser: polished cream

Fonte luminosa - Light source

220-240V: 1 x E27 LED
110V: 1 x E26 LED

Desk, ap - interruttore rotativo ON-OFF su base / FI - Dimmerabile su richiesta, disponibile versione con dimmer per LED su piede, compatibile solo con lampadine LED
Desk, ap- rotary ON-OFF switch on the base / FI - Dimmable on request, available, on demand, dimmer switch on the cable (to use dimmable LED light bulbs only)

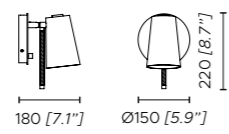

Ap

Vegas

Massimiliano Raggi



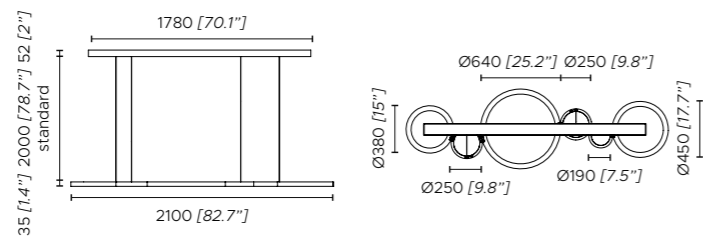

1. Rosone bronzo spazzolato

2. Anello grande in legno bronzo scuro

3. Anelli piccoli in legno bronzo chiaro

4. Dischi diffusori in alicrite effetto alabastro

1. Satin bronze canopy

2. Larger ring dark bronze painted wood

3. Smaller rings in light bronze painted wood

4. Alicrite diffusing discs with alabaster effect

Fonte luminosa - Light source

220-240V: 3 x 12W COB LED + 2 x 10W Panel LED + 1 x 8W Panel LED

110V: 3 x 12W COB LED + 2 x 10W Panel LED + 1 x 8W Panel LED

COB LED - dimmerabile, compatibile con sistemi di controllo remoto

COB LED - dimmable, compatible with remote control system



**Sartoria
Tailoring**

Athena

Massimiliano Raggi



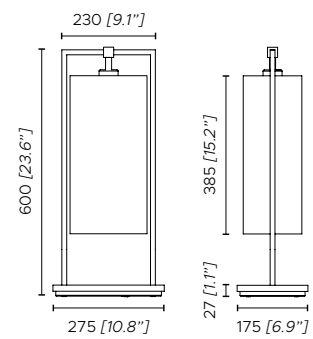

Struttura / Frame



1.



2.

1. Nickel lucido / *Polished nickel*
 2. Rovere tinto marrone scuro / *Dark brown stained oak*

Paralume / Shade



1.

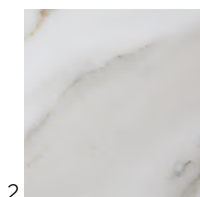

2.

1. Cotone bianco / *white cotton*
 2. Tessuto effetto marmo bianco Calacatta / *White Calacatta marble printed fabric*

Fonte luminosa - Light source

220-240: 1 x E27 LED
 110: 1 x E26 LED

Dimmerabile su richiesta, disponibile versione con dimmer per LED su cavo, compatibile solo con lampadine LED
 Dimmable on request, available, on demand, dimmer witch on the cable (to use dimmable LED light bulbs only)

Circus & Circus led

Contardi Studio





Struttura / Frame



Laccato bianco / white lacquered

Paralume / Shade



1. Cotone bianco / white cotton
2. Lino bianco / white linen
3. Tessuto effetto marmo bianco Calacatta / White Calacatta marble printed fabric
4. Bouclé color sabbia / Sand colour Bouclé

 *Altri tessuti e altezze sono disponibili su richiesta
Other fabrics and shade heights available on demand*

Passamaneria opzionale / Optional trim



1. Senape / Mustard
2. Rosso / Red
3. Azzurro / Light blue
4. Blu scuro / Dark blue
5. Grigio / Gray
6. Nero / Black

 *Altri colori di passamanerie sono disponibili su richiesta
Other trim colours available on demand*

Fonte luminosa Circus - Circus light source

220-240: 50-75 3 x E27 LED / 90-120-150 4 x E27 LED
110: 50-75 3 x E26 LED / 90-120-150 4 x E26 LED

Fonte luminosa Circus LED - Circus LED light source

220-240: 50-75 1 x 53W piastra LED custom / 90-120-150 1 x 70W piastra LED custom
110: 50-75 1 x 53W custom LED plate / 90-120-150 1 x 70W custom LED plate

Dimmerabile, compatibile con sistemi di controllo remoto
Dimmable, compatible with remote control system

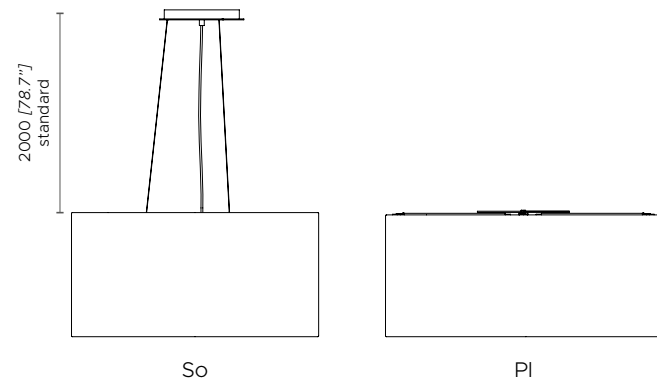

Circus

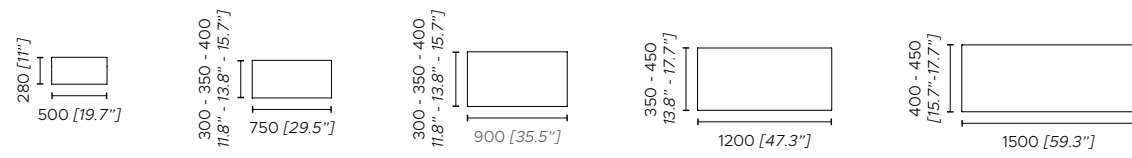

Circus LED

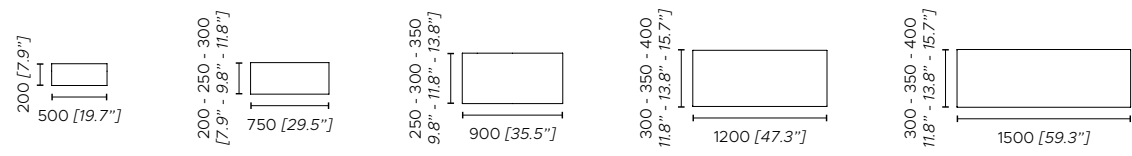

Coco Mega & Deluxe

Tristan Auer



Struttura / Frame



1.

1. Nickel lucido / *Polished nickel*

Paralume / Shade

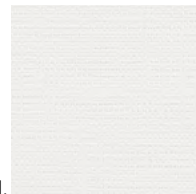

1.

1. Lino bianco / *White linen*

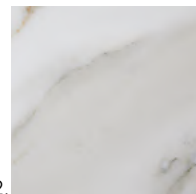

2.

2. Tessuto effetto marmo bianco Calacatta / *White Calacatta marble effect fabric*

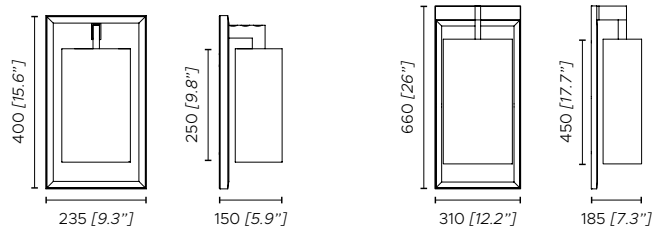

Coco Deluxe Ap

Coco Mega Ap

Fonte luminosa - Light source

220-240: 1 x E27 LED

110: 1 x E26 LED

Mega ap, deluxe ap - dimmerabile, compatibile con sistemi di controllo remoto / Mega ta, deluxe ta - dimmerabile su richiesta, disponibile versione con dimmer per LED su cavo, compatibile solo con lampadine LED

Mega ap, deluxe ap - dimmable, compatible with remote control system / Mega ta, deluxe ta - dimmable on request, available dimmer switch on the cable (to use dimmable LED light bulbs only)

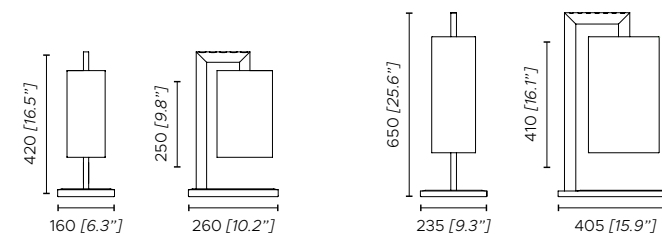

Coco Deluxe Ta

Coco Mega Ta





Coco & Coconette

Tristan Auer

Struttura / Frame



1.



2.

Coco - Coco Mini IP44
1. Nickel lucido / *Polished nickel*

Coconette
2. Bronzo spazzolato chiaro opaco / *Matt light satin bronze*

Paralume / Shade

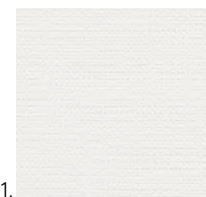

1.

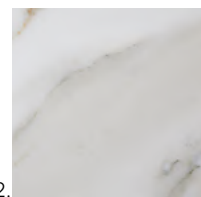

2.



3.

Coco Ap - Coconette Ap
1. Cotone bianco / *White cotton*
2. Tessuto effetto marmo bianco Calacatta / *White Calacatta marble effect fabric*

Coco Ap Mini IP44
3. Tessuto impermeabile bianco / *Waterproof white fabric*

Fonte luminosa - Light source
220-240: Coco & Coconette 1 x E27 LED - Coco Mini IP44 1 x G9 LED
110: Coco & Coconette 1 x E26 LED - Coco Mini Ip44 1 x G9 LED

Dimmerabile, compatibile con sistemi di controllo remoto
Dimmable, compatible with remote control system



Coconette



Coco

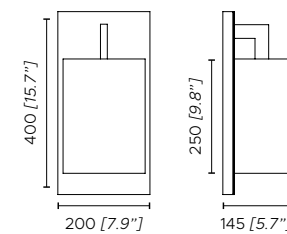

Coconette

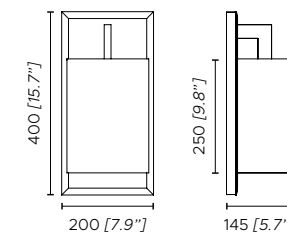

Coco

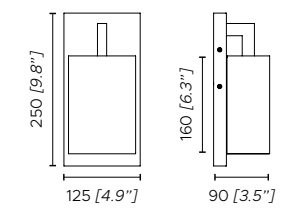

Coco Mini IP44



Ovale

Contardi Studio

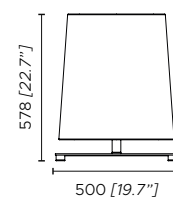

Ta



Ta small



Struttura / Frame



1.



2.

1. Bronzo spazzolato chiaro opaco / *Matt light satin bronze*
 2. Laccato nero seta opaco / *Matt black lacquered silk*

Paralume / Shade



1.

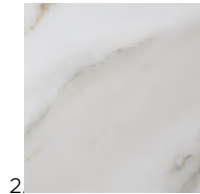

2.

1. Cotone bianco / *white cotton*
 2. Tessuto effetto marmo bianco Calacatta /
White Calacatta marble printed fabric

 *Passamanerie disponibili su richiesta*
Trims available on demand

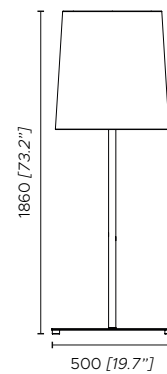

Fonte luminosa - Light source

220-240: 1 x E27 LED
 110: 1 x E26 LED

Dimmerabile su richiesta, disponibile versione con dimmer per LED su cavo, compatibile solo con lampadine LED
 Dimmable on request, available dimmer switch on the cable (to use dimmable LED light bulbs only)





Ap

Ap led

Struttura / Frame

1.

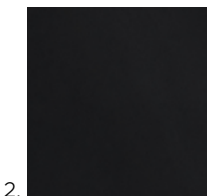

2.

1. Bronzo spazzolato chiaro opaco / *Matt light satin bronze*
 2. Laccato nero seta opaco / *Matt black lacquered silk*

Paralume / Shade

1.

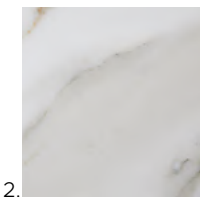

2.

1. Cotone bianco / *white cotton*
 2. Tessuto effetto marmo bianco Calacatta / *White Calacatta marble printed fabric*

 *Passamanerie disponibili su richiesta*
Trims available on demand

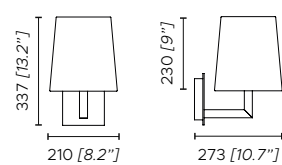

Ap

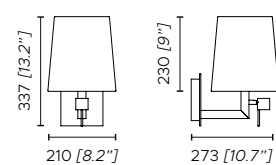

Ap led

Fonte luminosa - Light source

220-240: Ap / Ta / TA desk / FI / Liseuse 1 x E27 LED - Ap LED 1 x E27 LED + 1 x 3W Custom LED
 110: Ap / Ta / TA desk / FI / Liseuse 1 x E26 LED - Ap LED 1 x E26 LED + 1 x 3W Custom LED

Ap - dimmerabile, compatibile con sistemi di controllo remoto / Ta, ta desk, fl, liseuse - dimmerabile su richiesta, disponibile versione con dimmer per LED su cavo, compatibile solo con lampadine LED
 Ap - dimmable, compatible with remote control system / Ta, ta desk, fl, liseuse - dimmable on request, available dimmer switch on the cable (to use dimmable LED light bulbs only)

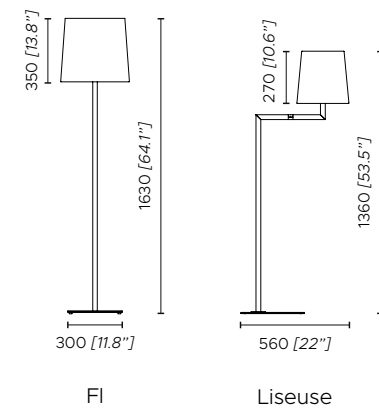
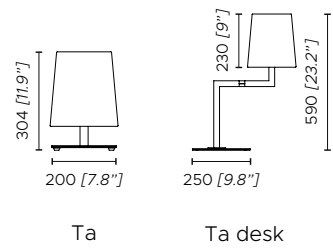

 **contardi**

outdoor



BLENDING
TECHNOLOGY
& CREATIVE
DESIGN



1. Lo stile incontra la sostanza **Timeless design created in Italy**

La nostra Collezione Outdoor è un chiaro esempio di questa combinazione ideale: un modo per portare all'esterno il mondo indoor, mantenendo le stesse caratteristiche decorative e di qualità del prodotto per interni, senza dimenticare l'aspetto pragmatico relativo alla destinazione d'uso. L'utilizzo di materiali e tessuti decorativi di alta qualità è combinato con finiture e caratteristiche richieste dai più alti standard, tra cui la certificazione IP65 e il trattamento di cataforesi "Marine Grade".

We at Contardi interpret the outdoor collection as a way to bring the interior design to the open-air. The idea is to keep the same decorative and qualitative characteristics of the indoor products without forgetting the pragmatic aspect, specifically the intended use. The use of high-quality decorative materials and fabrics is successfully combined with finishes and regulations required for the highest standards, such as the IP65 and the "Marine Grade".

B

6 **BABU**

C

14 **CALYBABU**
18 **CALYPSO OUTDOOR** so, fl
32 **COCO OUTDOOR**
36 **CUBE OUTDOOR** wired, battery

F

42 **FREEDOM** wired, battery

L

48 **LAGO**

M

52 **MUSE LANTERN OUTDOOR** so,wired, battery
60 **MUSE OUTDOOR** so, wired, battery, fl

T

68 **TENEBRA** wired, battery

Lampada a parete
Wall lamp

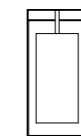

Coco Outdoor
32



Freedom
42

Lampada a sospensione
Suspension lamp



Calypso Outdoor
18



Muse Lantern Outdoor
52



Muse Outdoor
60



Tenebra
68

Lampada da terra & pouf
Floor lamp & pouf



Babu
6



Calypso Outdoor
18



Cube Outdoor
36



Freedom
42

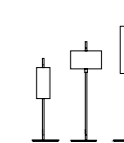

Lago
48



Muse Lantern Outdoor
52



Muse Outdoor
60



Calybabu
14

Lampada da tavolo
Table lamp



Freedom
42



Muse Lantern Outdoor
52



Muse Outdoor
60

Lampada a batteria
Battery lamp



Cube Outdoor
36



Freedom
42



Muse Lantern Outdoor
52



Muse Outdoor
60

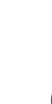

Tenebra
68

Babu

Massimiliano Raggi



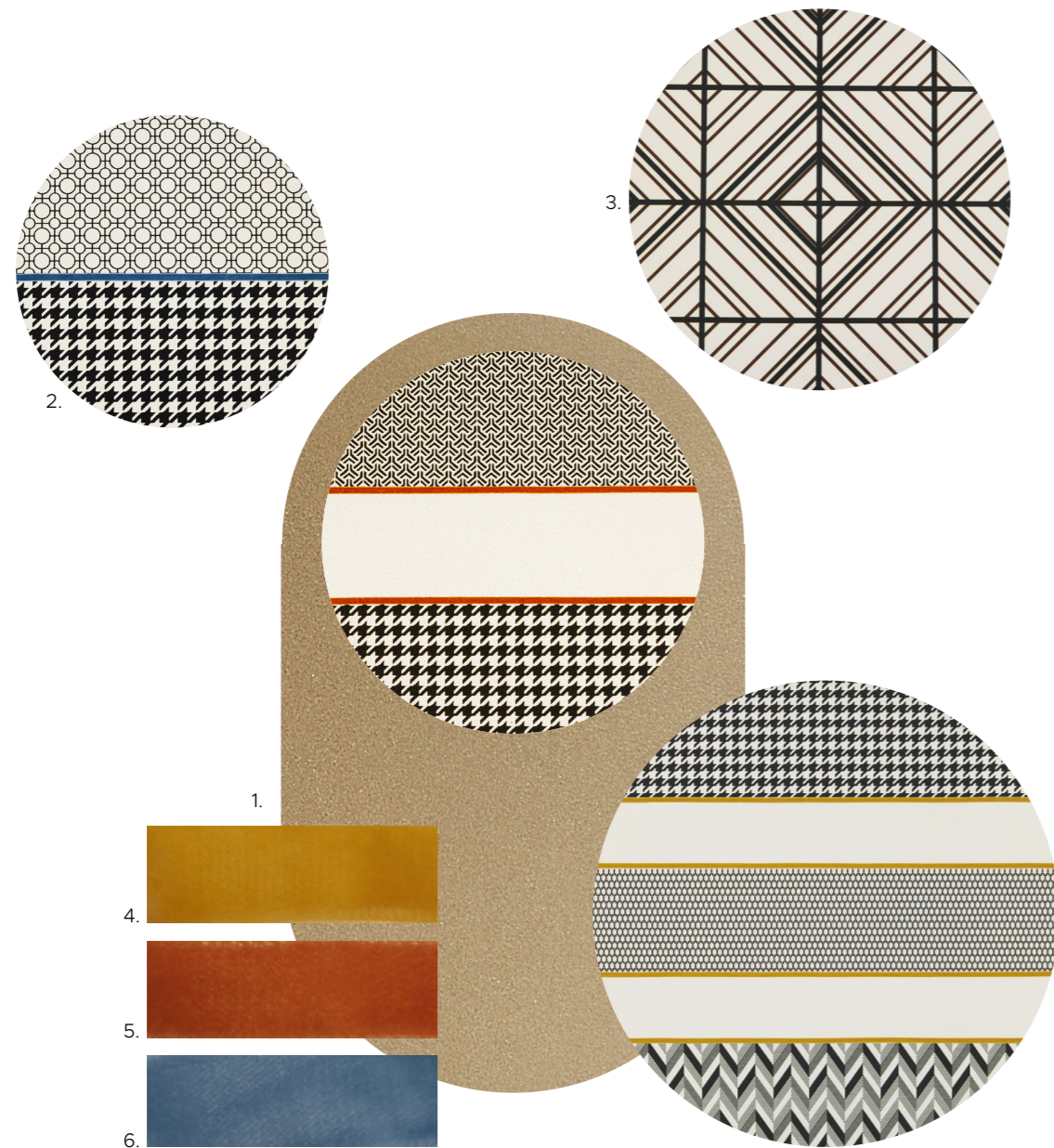

1. Acciaio laccato effetto champagne, trattamento cataforesi Marine Grade

2. Stampa Textile digitale 3D su tessuto S, M & L
3. Stampa Tribal digitale 3D su tessuto

4. Passamaneria in velluto outdoor senape
5. Passamaneria in velluto outdoor arancio
6. Passamaneria in velluto outdoor blu avio

① *Stampa digitale 3D su tessuto personalizzabile su richiesta*

1. Champagne painted steel, Marine Grade with cataphoresis treatment

2. 3D digital Textile printing on fabric S, M & L
3. 3D digital Tribal printing on fabric

4. "Mustard colour" velvet trim for outdoor use
5. "Orange colour" velvet trim for outdoor use
6. "Aviation blue colour" velvet trim for outdoor use

① *3D digital printing on customizable fabric*

Fonte luminosa - Light source
220-240V: Strip LED 1 x 17/24/34 W
110V: Strip LED 1 x 17/24/34 W

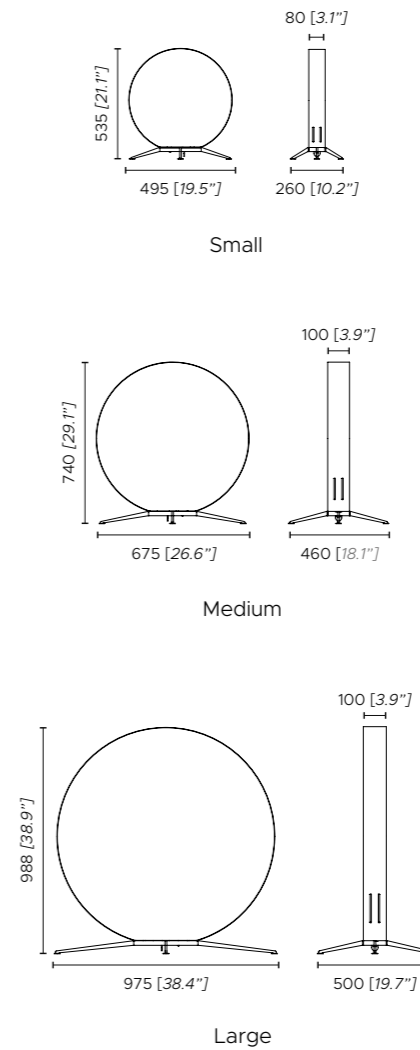



STAMPA 3D **TEXTILE & TRIBAL**
3D PRINT **TEXTILE & TRIBAL**

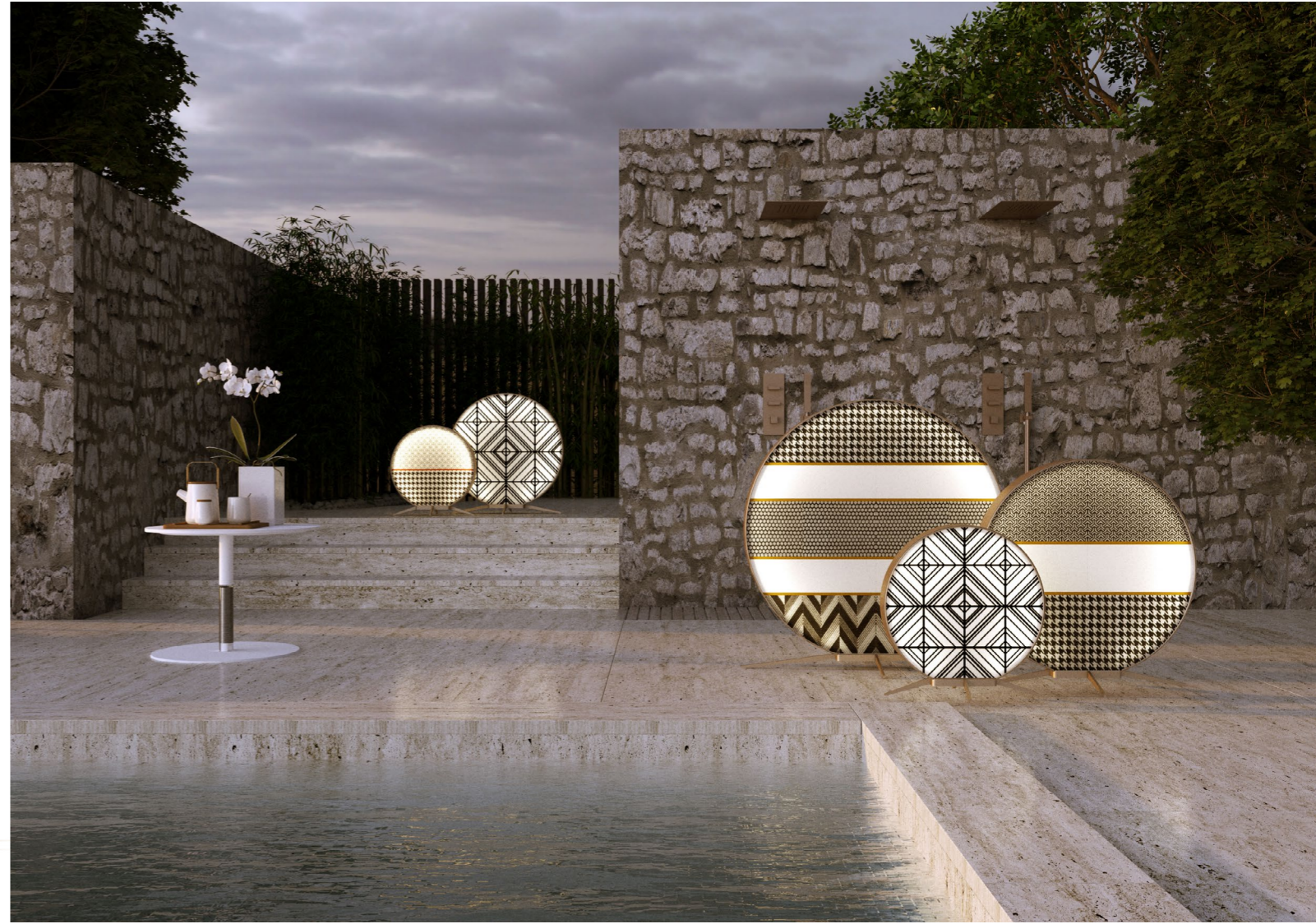

Calybabu

Massimiliano Raggi



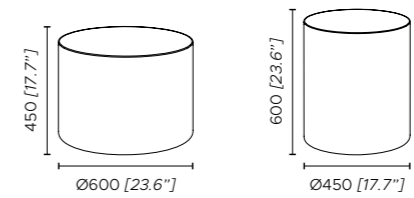

1. Pattern H
2. Pattern I
3. Pattern L

4. Pattern M
5. Pattern N

Calypso outdoor

Servomuto





1. Ottone satinato
2. Corda da marina impermeabile intrecciata in tinta verde
3. Paralume SO: Antigua, Guadaloupe, Martinique
4. Diffusore vetro trasparente

Fonte luminosa - Light source
 220-240V: 1 x E27 T8 Tubolar LED
 110V: 1 x E26 T8 Tubolar LED

1. Satin brass
2. Green waterproof braided rope
3. SO shade: Antigua, Guadaloupe, Martinique
4. Transparent glass diffuser



CALYPSO SO



Antigua
Mint



Guadeloupe
Mint



Martinique
Yellow



Antigua
Black



Guadeloupe
Black



Martinique
Black



Antigua
Sale & Pepe



Guadeloupe
Sale & Pepe



Martinique
Building

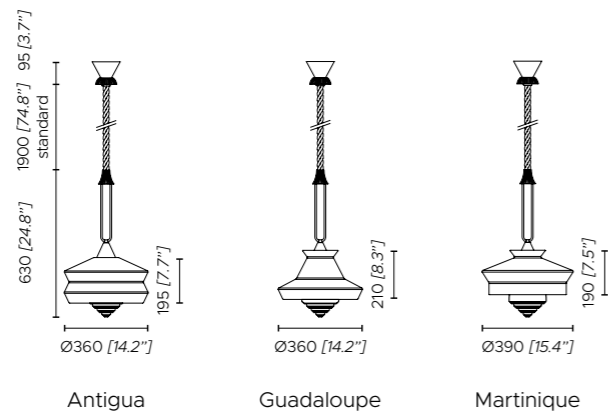



CALYPSO SO XL



Antigua
Mint



Guadeloupe
Sale & Pepe



Martinique
Yellow

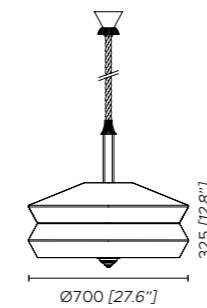

Antigua

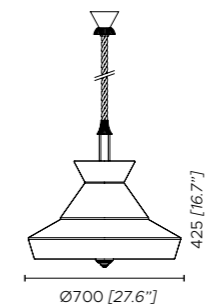

Guadeloupe

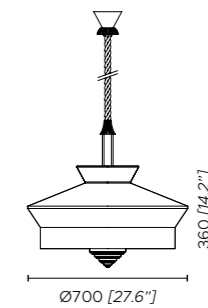

Martinique

Fonte luminosa - Light source
220-240V: 1 x E27 T8 Tubular LED
110V: 1 x E26 T8 Tubular LED



CALYPSO
**FLOOR
OUTDOOR**
Servomuto



GEOMETRIC
PATTERNS
& BRIGHT
COLOURS

TRAME GEOMETRICHE & COLORI BRILLANTI

Fl Single

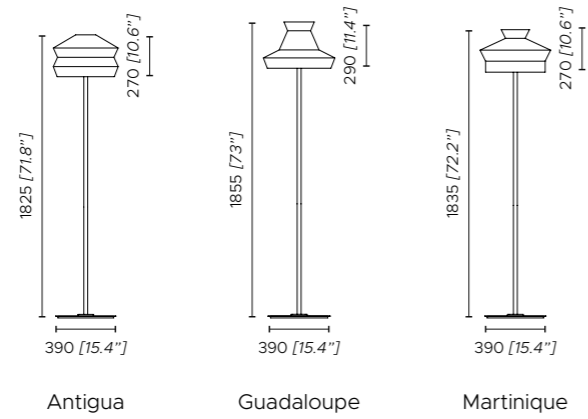

Fl+Table

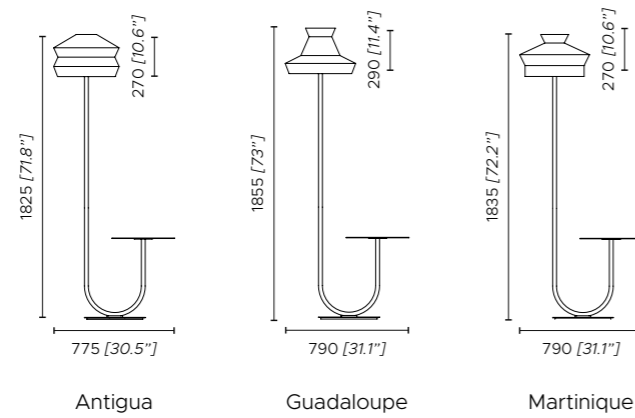

- 1. Laccato nero opaco
- 2. Laccato verde reseda

3. **Paralumi:** Antigua, Guadeloupe, Martinique

- 1. Matt black lacquered
- 2. Reseda green lacquered

3. **Shades:** Antigua, Guadeloupe, Martinique

Fonte luminosa - Light source
 220-240V: 1 x E27 T8 Tubolar LED
 110V: 1 x E26 T8 Tubolar LED



Coco outdoor

Tristan Auer



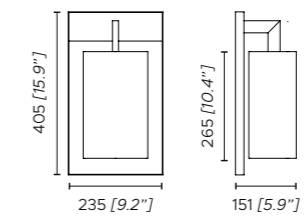

Small

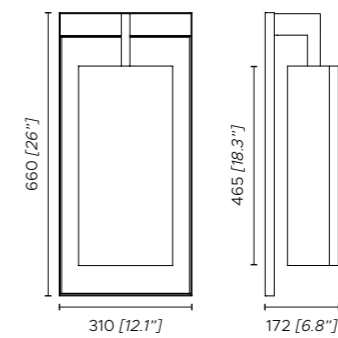

Mega

- 1. Acciaio spazzolato
- 2. Legno marino in mocha scuro con trattamento impermeabilizzante
- 3. Tessuto impermeabile Sale e Pepe

- 1. Satin steel
- 2. Dark mocha marine wood with waterproof treatment
- 3. Sale e Pepe waterproof fabric

Fonte luminosa - Light source
 220-240V: 1 x E27 LED
 110V: 1 x E26 LED



Cube outdoor

Massimiliano Raggi

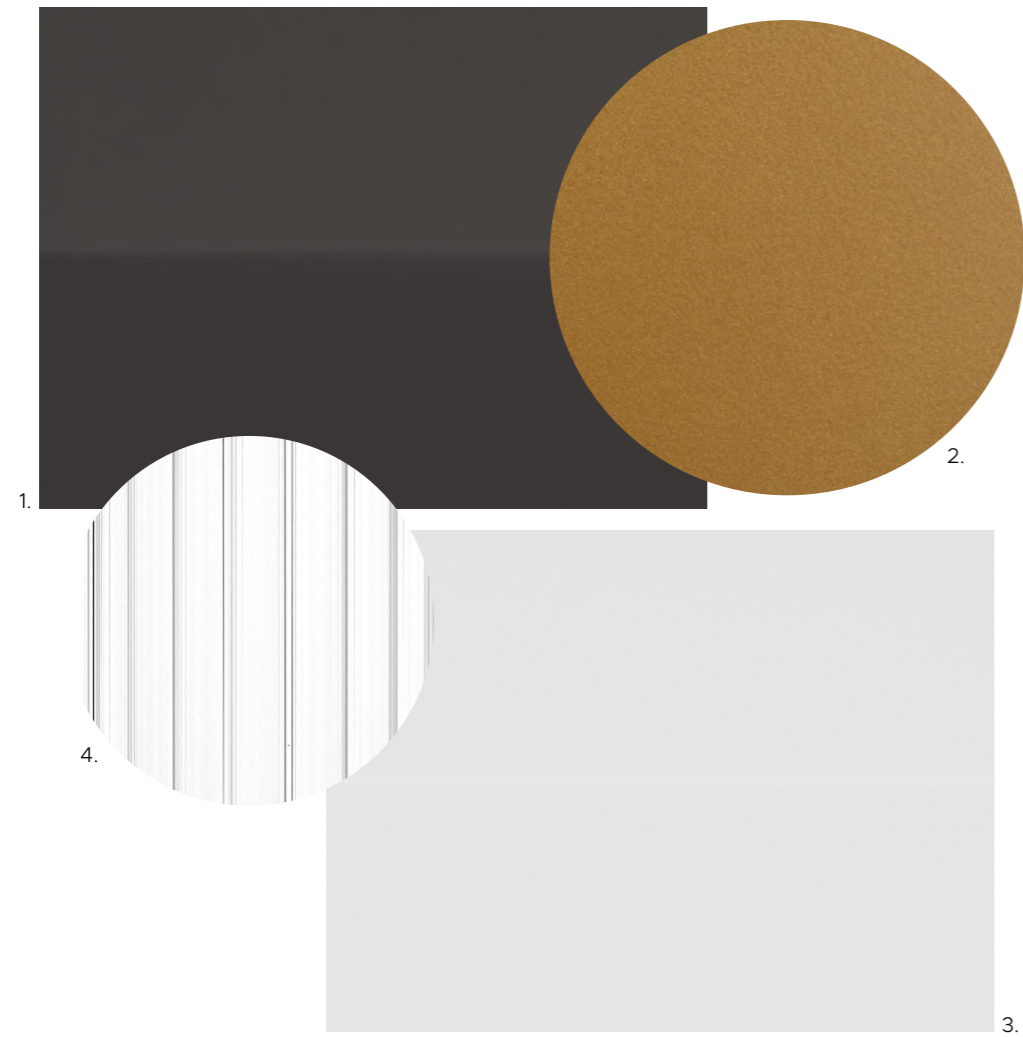

- 1. Esterno: bronzo scuro
- 2. Interno: laccato oro, trattamento cataforesi Marine Grade
- 3. Laccato bianco opaco, trattamento cataforesi Marine Grade
- 4. Diffusore plexiglass satinato

- 1. Outside: dark bronze
- 2. Inside: gold lacquered, Marine Grade with cataphoresis treatment
- 3. Matt with lacquered, Marine Grade with cataphoresis treatment
- 4. Satin plexiglass diffuser

Fonte luminosa - Light source

220-240V: Wired version 1 x E27 LED / Battery version 1 x 3W Custom LED
 110V: Wired version 1 x E26 LED / Battery version 1 x 3W Custom LED

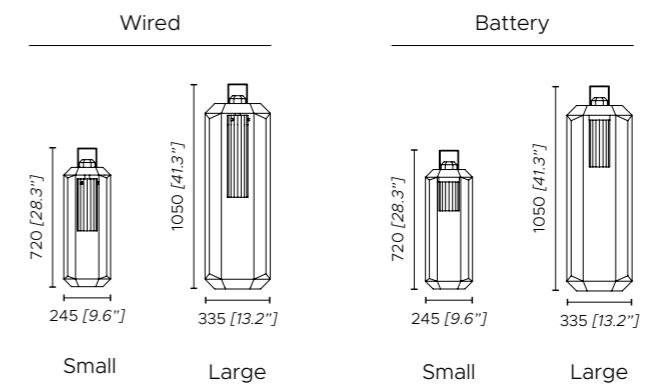



BATTERY OPERATED / **A BATTERIA**



ACCENSIONE / SPEGNIMENTO
ON/OFF SWITCHING

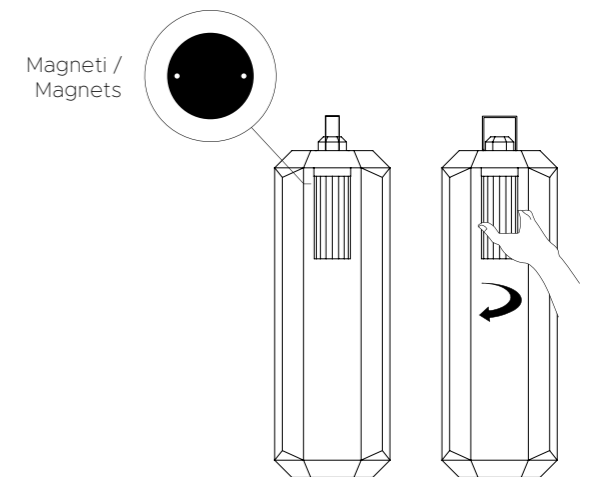

Freedom

Massimiliano Raggi



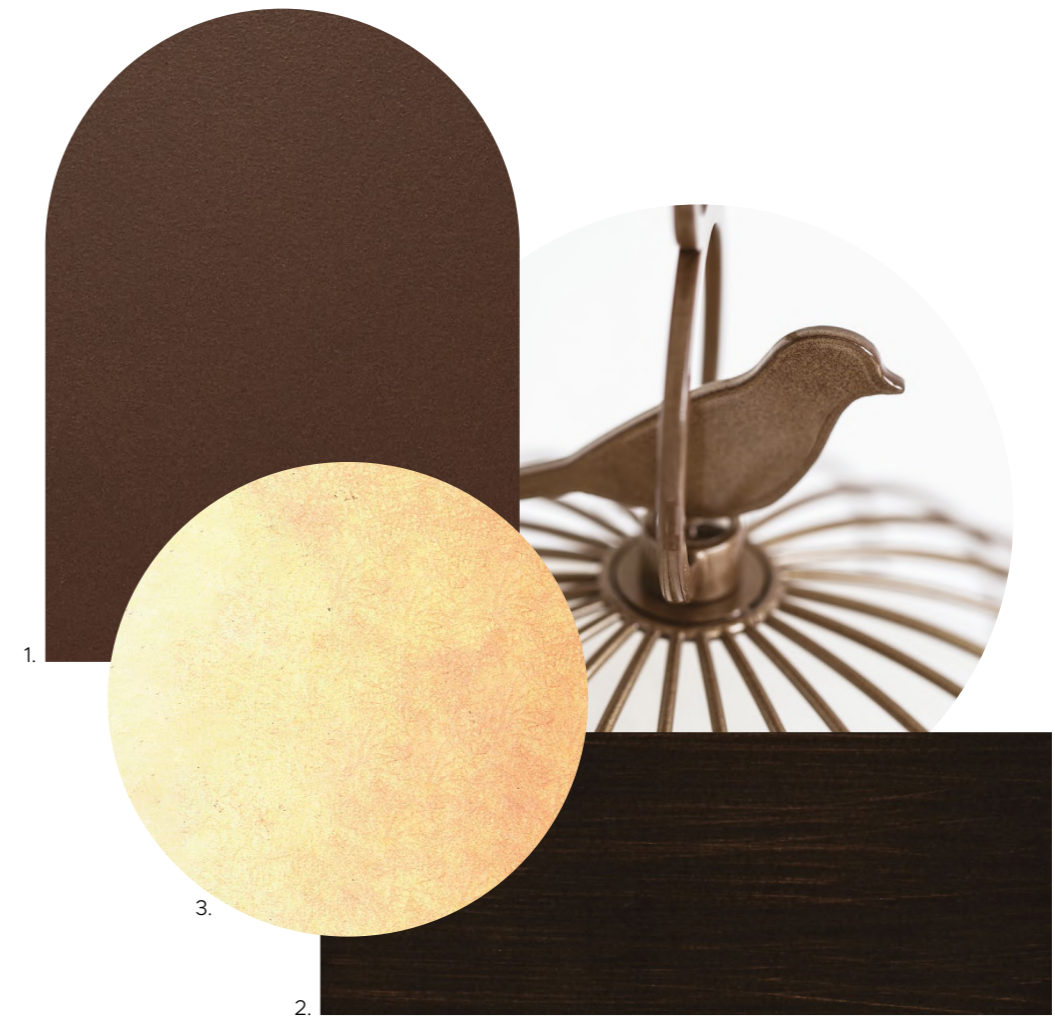

1. Gabbia in metallo verniciato bronzo
2. Base in legno marino marrone scuro con trattamento cataforesi
3. Diffusore vetroresina crema

1. Cage in bronze painted metal
2. Dark brown marine wood with waterproof treatment for the base
3. Cream-coloured fiberglass diffuser

Fonte luminosa - Light source

220-240V: Wired version 1 x E27 LED / Battery version 1 x 3W Custom LED
 110V: Wired version 1 x E26 LED / Battery version 1 x 3W Custom LED



ACCESSORI / ACCESSORIES FREEDOM BATTERY



Gancio da parete
Hook for wall

Gancio per piantana
Hook for floor

Piastra da terra
Ground plate

Lago

Servomuto



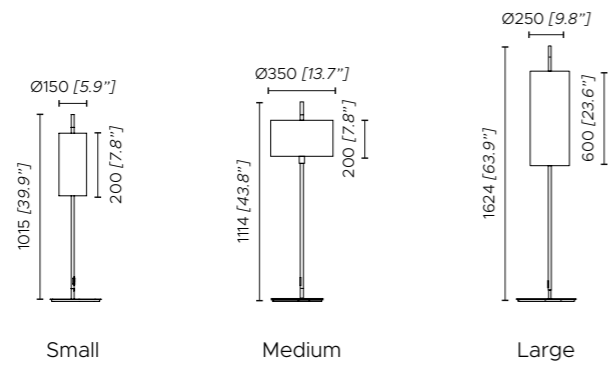

- 1. Laccato nero opaco
- 2. Laccato rame
- 3. Paralume Bayamo Mimosa (Pierre Frey)
- 4. Paralume Noumea Goyave (Pierre Frey)
- 5. Paralume Dominica Caraibes (Pierre Frey)

- 1. Matt black laquered
- 2. copper lacquered
- 3. Bayamo Mimosa shade (Pierre Frey)
- 4. Noumea Goyave shade (Pierre Frey)
- 5. Dominica Caraibes shade (Pierre Frey)

Fonte luminosa - Light source
 220-240V: 1 x E27 T8 Tubolar LED
 110V: 1 x E26 T8 Tubolar LED



VERSIONE A PICCHETTO
PICKET VERSION

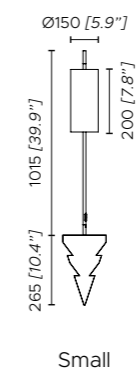

Muse lantern outdoor

Tristan Auer



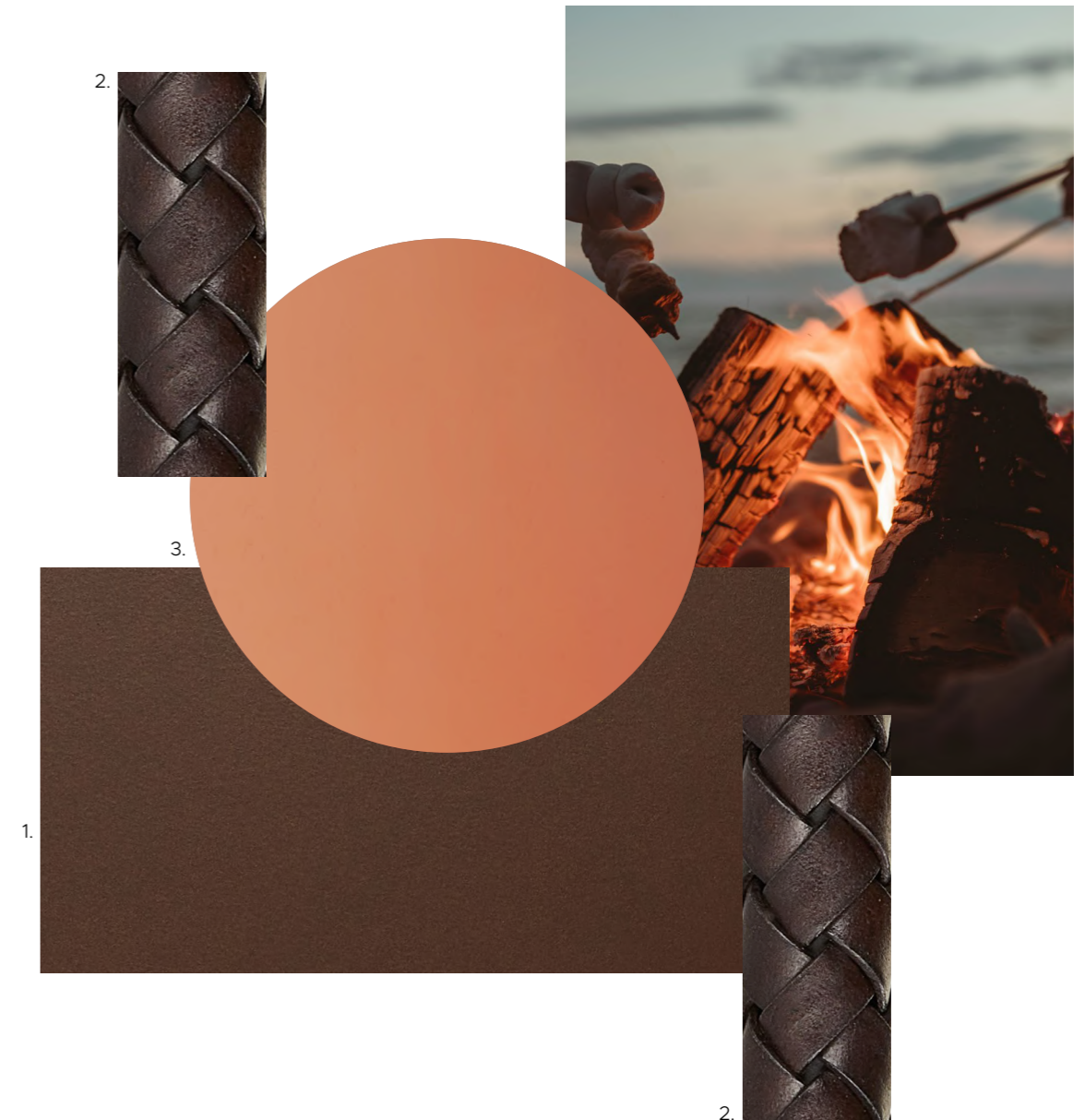

Battery

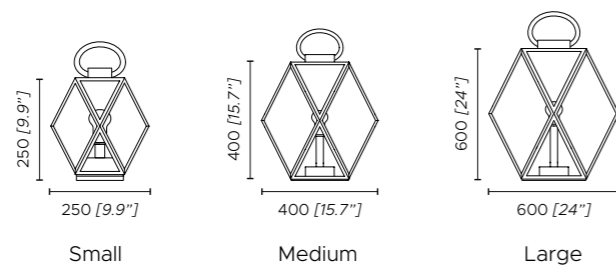

- 1. Laccato bronzo trattamento cataforesi Marine Grade
- 2. Maniglia in cuoio intrecciata marrone
- 3. Acrilico color ambra

- 1. Bronze lacquered Marine Grade with cataphoresis treatment
- 2. Brown braided leather handle
- 3. Amber finish acrylic

Fonte luminosa - Light source

220-240V: Wired version 1 x E27 LED / Battery version 1 x 3W Custom LED
 110V: Wired version 1 x E26 LED / Battery version 1 x 3W Custom LED

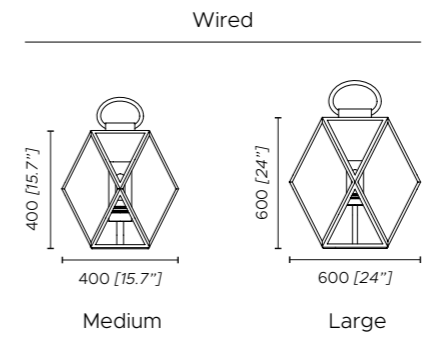

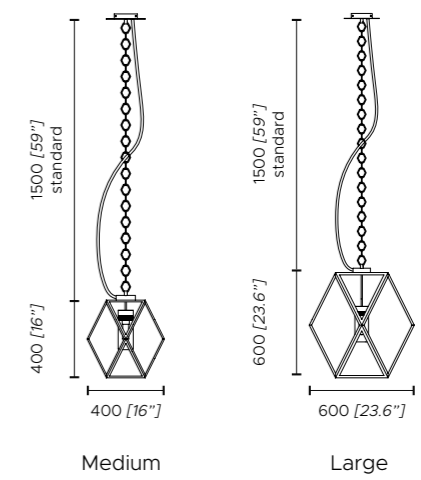

Muse outdoor

Tristan Auer



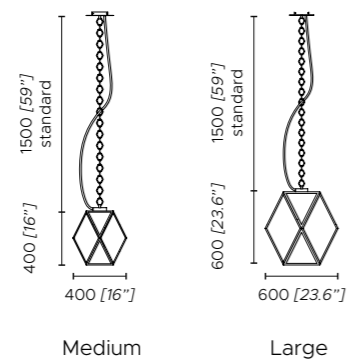

- 1. Laccato bianco opaco
Trattamento cataforesi Marine Grade
- 2. Laccato nero opaco
Trattamento cataforesi Marine Grade
- 3. Maniglia in cuoio intrecciato bianco/nero
- 4. Diffusore acrilico satinato

- 1. Matt white lacquered
Marine Grade with cataphoresis treatment
- 2. Matt black lacquered
Marine Grade with cataphoresis treatment
- 3. Black/white braided leather handle
- 4. Satin finish acrylic diffuser

Fonte luminosa - Light source

220-240V: Wired version 1 x E27 LED / Battery version 1 x 3W Custom LED
 110V: Wired version 1 x E26 LED / Battery version 1 x 3W Custom LED



Wired

Battery

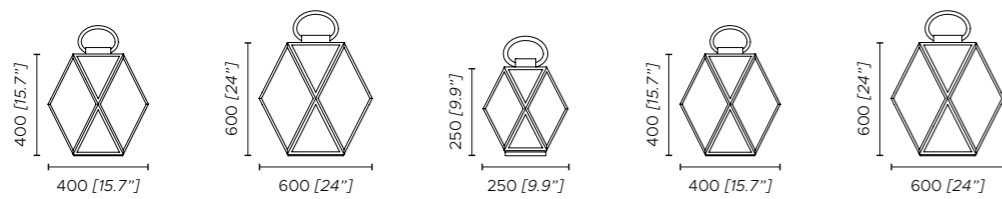



Tenebra

Jan Van Lierde



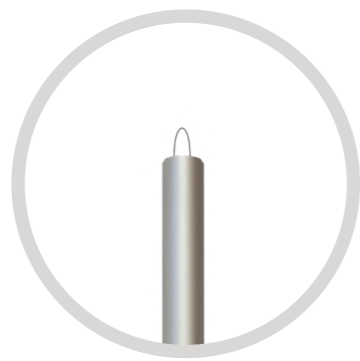

VERSIONE A BATTERIA,
SENZA ROSONE
**BATTERY OPERATED
VERSION, WITHOUT CANOPY**

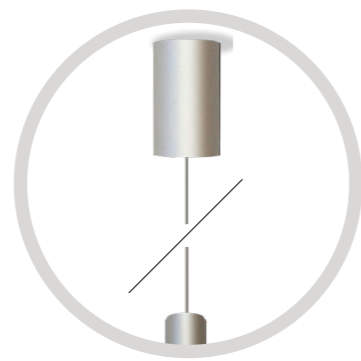

VERSIONE CABLATA,
CON ROSONE
**WIRED VERSION,
WITH CANOPY**

- 1. Laccato nero seta opaco
- 2. Laccato oro rosa
- 3. Laccato argento

- 1. Matt black silk finish
- 2. Rose gold finish
- 3. Silver finish

Fonte luminosa - Light source
220-240V: 1 x 3W LED
110V: 1 x 3W LED

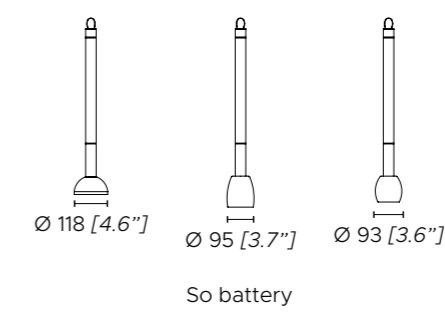
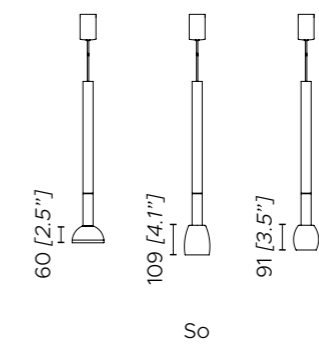



ACCESSORI / ACCESSORIES TENEBRA



1.



2.



3.

- 1. Diffusore cristallo sintetico, "Venezia ambra"
- 2. Diffusore cristallo sintetico, "Lente grigio"
- 3. Diffusore cristallo sintetico "Crystal Macedonia"

- 1. Diffuser syntethic crystal, "Venezia Amber"
- 2. Diffuser syntethic crystal, "Grey lens"
- 3. Diffuser syntethic crystal, "Crystal Macedonia"

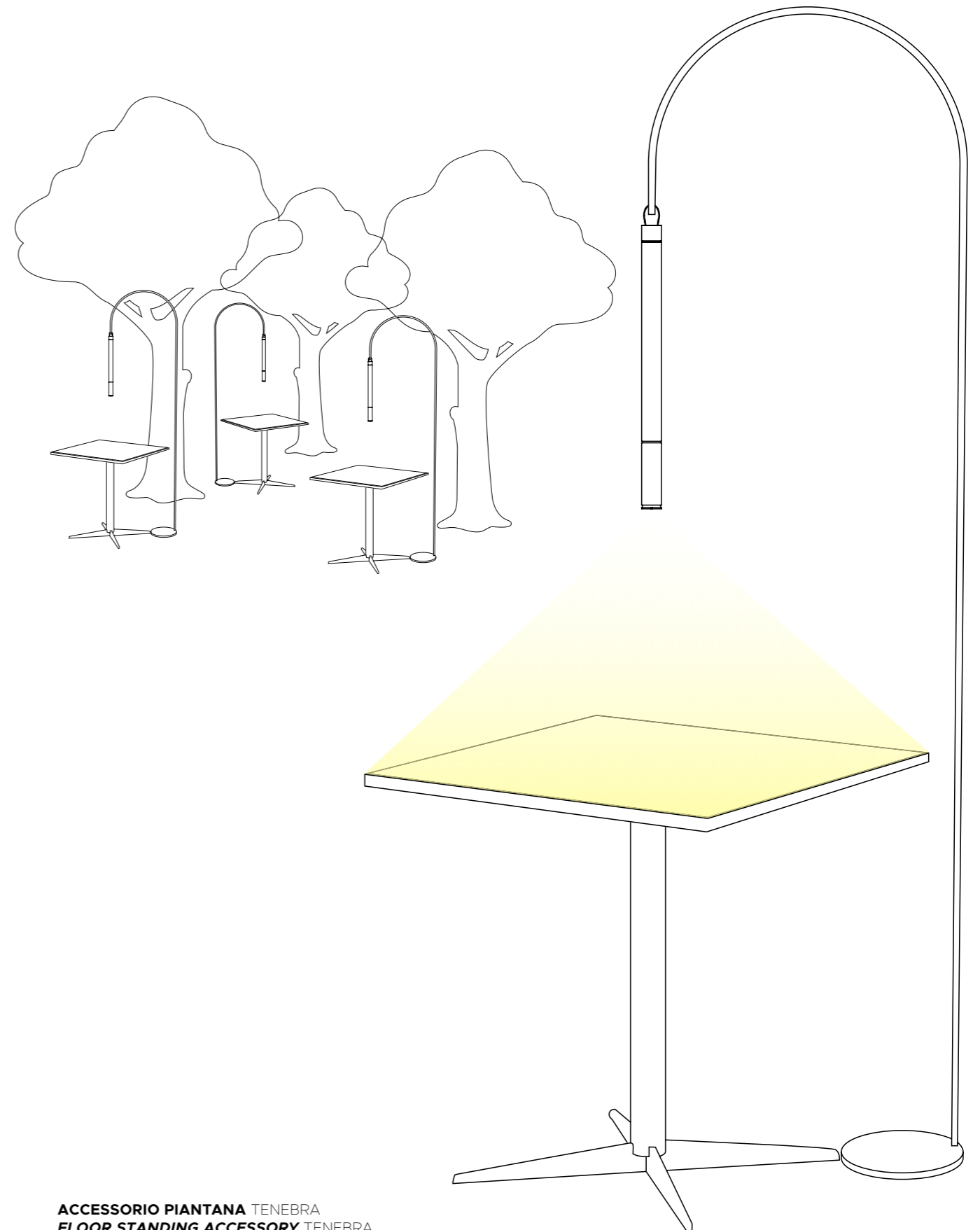

ACCESSORIO PIANTANA TENEBRA
FLOOR STANDING ACCESSORY TENEBRA



THANKS TO

Graphic Project:

Claudia Parisi

Photo Creative Direction:

STUDIOBLUM

Styling:

Martina Caiazza

Mise en page:

Martina Castiglieri

Photos:

Francesco Romeo

Lakeroom

Render:

Operavisual

Studio Massimiliano Raggi

MKV Design

Photos of page:

Casablanca Fotografia (p. 67)

Fabio Grande (p. 71)

Milène Servelle Photographe (p. 159)

Yvan Grubski Phothographer (p.7_i)

Francis Amiand Photographe (p. 62_out)

Stuart Pearce (p. 71_out)

Styling of page:

John Mac Donald, Tilburg (p. 38, 196)

BenchMark Design, Tilburg (p. 41)

MPMC Design, Monaco (FR) (p. 53)

NB-Studio, Moscow (p. 65)

Joaquim Homs (p. 67)

Alessandra Notarangelo Architetto, Italy (p. 71)

Grani Studio, Sochi (p. 110)

Tamma Architecture, Monaco (FR) (p. 159)

Goddard Little Fair, London (p. 190)

Maurizio Di Mauro Architetto, Italy (p. 192)

Maison Numéro 20 / Oscar Lucien Ono, Paris (p. 62_out)

Gunter & Co Interiors, London (p. 69_out)

FM Architettura d'interni, Italy (p. 71_out)

Thanks to:

MONOMIO

Ilya Barton

Jole Lombardini

Marco Billotti

Stefano Mandelli

Meroni e Colzani

CTS Salotti

Casa Casati

On House Milan

Thesign srl

Buro Tsum Restaurant, Moscow

Cavo Tagoo, Mykonos

Motel One Frankfurt Römer, Frankfurt

Fonteverde Hotel, San Casciano dei Bagni

Bartolo & Sons, Palermo

Egetemeier Wohnkultur, Germany

Sabrina Montecarlo, Monaco (FR)

Four Season Hotel Megeve, France

Print:

Grafiche Filacorda, Udine

©Contardi Lighting srl

02.2022